

PR 4

POWER SYSTEM PROTECTION SCHEMES

Protection Scheme

A protection scheme consists of fault detectors and isolating equipment, capable of disconnecting faulty equipment from the power system.

The Need for Protection on a Power System

Protection is needed to remove as quickly as possible, any element of a power system in which a fault has occurred.

If the fault remains connected to the power system, there is a risk that the whole system may be in danger from:

- a) damage to the faulted equipment,
- b) damage to healthy equipment supplying the fault,
- c) individual generators in a power station, or individual power stations losing synchronism, with consequent splitting of the power system,

Any of these occurrences may result in undesirable interruption to customer supply and costly damage to assets.

Types of Fault Conditions

Abnormal operating conditions on a power system, are undesirable.

Abnormal conditions include:

- a) excessive current flow due to overload or short circuit,
- b) excessive voltage or under voltage,
- d) high or low system frequency,
- e) reverse power flow in a generator.

Not all of these abnormal conditions result from a short circuit on the power system, but they may result in unacceptable quality of supply, and/or damage to HV equipment.

Monitoring of System Conditions to Detect Faults

As excessive current is not the only abnormal condition on a power system, detection of fault conditions on a large interconnected system requires continuous monitoring of system currents, voltages, frequency and direction of power flow.

Various fault detectors capable of identifying abnormal conditions, must be installed to cover every possible type of abnormal operating condition.

These transformers are able to "step-up" (increase) the voltage to 330 000 volts and even 500 000 volts, which is about 800 and 1200 times respectively greater than the 240 volt single phase household supply. Thus high voltage helps electricity travel along the wires better.

The extra high voltage transmission system connects the power stations to large substations on the outskirts of the cities and major towns throughout the state. These substations transform the very high voltages down to 66 000 volts and 33 000 volts which is used for the sub-transmission system around the metropolitan area and some country districts. Zone substations have further step-down transformers which lower the voltage to 22 000 or 11 000 volts. Electricity at this voltage can then be transmitted on smaller, lighter power poles, until the supply is finally reduced to 240 volts by small transformers on wood poles or enclosed at ground level. Then the power goes out to homes, factories and offices.

Most houses receive their power supplies from overhead mains (wires) because it is cheaper than underground cables.

In New South Wales it is the responsibility of Pacific Power to operate the huge electricity generators and high voltage power lines. A single control centre at Carlingford in Sydney directs the operation of the state-wide transmission system.

At lower voltages electricity is distributed by 25 supply authorities usually called county councils. In Sydney these are called Sydney Electricity and Prospect Electricity. Sydney Electricity alone has over one million customers.

Energy Australia

Energy Australia and Integral Energy

How electricity is taken to the home

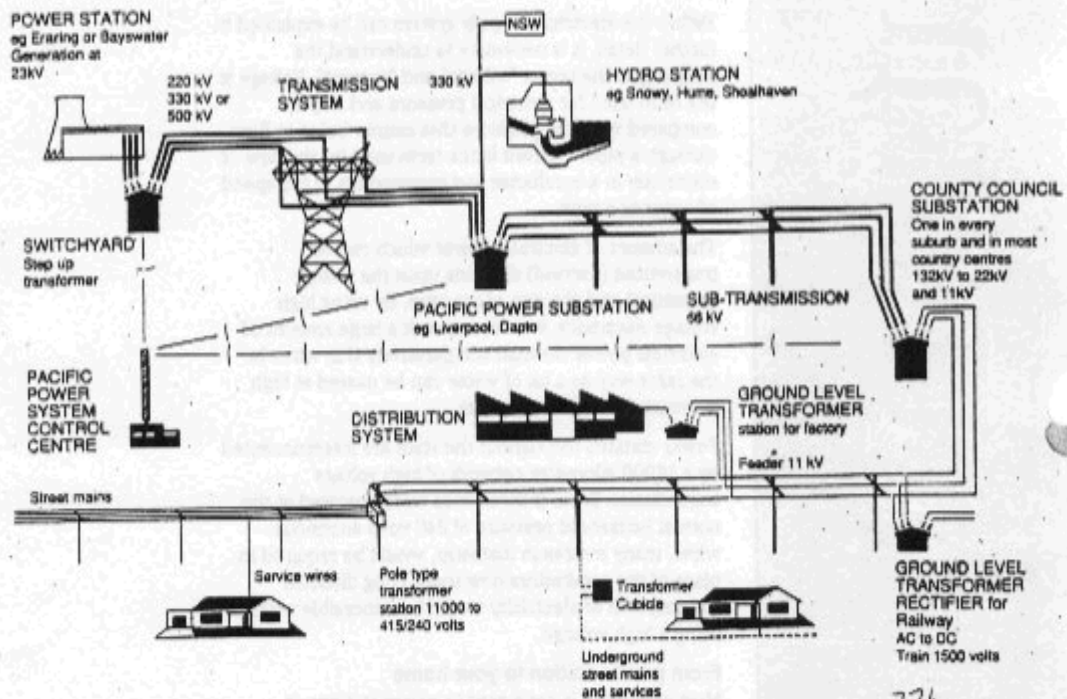

33kV

These transformers are able to "step-up" (increase) the voltage to 330 000 volts and even 500 000 volts, which is about 800 and 1200 times respectively greater than the 240 volt single phase household supply. Thus high voltage helps electricity travel along the wires better.

The extra high voltage transmission system connects the power stations to large substations on the outskirts of the cities and major towns throughout the state. These substations transform the very high voltages down to 66 000 volts and 33 000 volts which is used for the sub-transmission system around the metropolitan area and some country districts. Zone substations have further step-down transformers which lower the voltage to 22 000 or 11 000 volts. Electricity at this voltage can then be transmitted on smaller, lighter power poles, until the supply is finally reduced to 240 volts by small transformers on wood poles or enclosed at ground level. Then the power goes out to homes, factories and offices.

Most houses receive their power supplies from overhead mains (wires) because it is cheaper than underground cables.

In New South Wales it is the responsibility of Pacific Power to operate the huge electricity generators and high voltage power lines. A single control centre at Carlingford in Sydney directs the operation of the state-wide transmission system.

At lower voltages electricity is distributed by 25 supply authorities usually called county councils. In Sydney these are called ~~Sydney Electricity~~ and ~~Prospect Electricity~~ *Energy Australia* and *Integral Energy*. *Sydney Electricity* alone has over one million customers.

How electricity is taken to the home

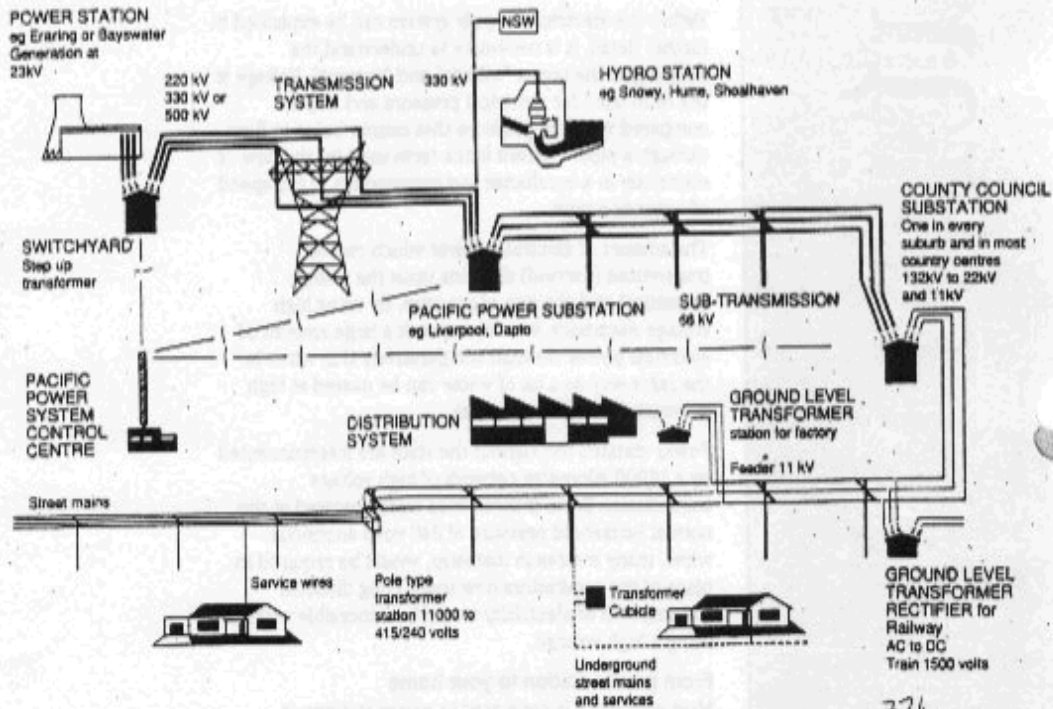

These transformers are able to "step-up" (increase) the voltage to 330 000 volts and even 500 000 volts, which is about 800 and 1200 times respectively greater than the 240 volt single phase household supply. This high voltage helps electricity travel along the wires better.

The extra high voltage transmission system connects the power stations to large substations on the outskirts of the cities and major towns throughout the state. These substations transform the very high voltages down to 66 000 volts and 33 000 volts which is used for the sub-transmission system around the metropolitan area and some country districts. Zone substations have further step-down transformers which lower the voltage to 22 000 or 11 000 volts. Electricity at this voltage can then be transmitted on smaller, lighter power poles, until the supply is finally reduced to 240 volts by small transformers on wood poles or enclosed at ground level. Then the power goes out to homes, factories and offices.

Most houses receive their power supplies from overhead mains (wires) because it is cheaper than underground cables.

In New South Wales it is the responsibility of Pacific Power to operate the huge electricity generators and high voltage power lines. A single control centre at Carlingford in Sydney directs the operation of the state-wide transmission system.

At lower voltages electricity is distributed by 26 supply authorities usually called county councils. In Sydney these are called Sydney Electricity and ~~Electricity~~ Electricity. Sydney Electricity alone has over one million customers.

Energy Australia and Integral Energy

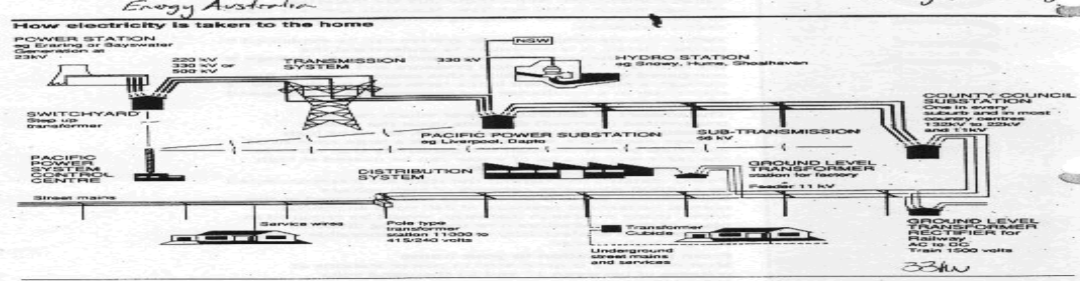

These transformers are able to "step-up" (increase) the voltage to 330 000 volts and even 500 000 volts, which is about 800 and 1200 times respectively greater than the 240 volt single phase household supply. Thus high voltage helps electricity travel along the wires better.

The extra high voltage transmission system connects the power stations to large substations on the outskirts of the cities and major towns throughout the state. These substations transform the very high voltages down to 66 000 volts and 33 000 volts which is used for the sub-transmission system around the metropolitan area and some country districts. Zone substations have further step-down transformers which lower the voltage to 22 000 or 11 000 volts. Electricity at this voltage can then be transmitted on smaller, lighter power poles, until the supply is finally reduced to 240 volts by small transformers on wood poles or enclosed at ground level. Then the power goes out to homes, factories and offices.

Most houses receive their power supplies from overhead mains (wires) because it is cheaper than underground cables.

In New South Wales it is the responsibility of Pacific Power to operate the huge electricity generators and high voltage power lines. A single control centre at Carlingford in Sydney directs the operation of the state-wide transmission system.

At lower voltages electricity is distributed by 25 supply authorities usually called county councils. In Sydney these are called ~~Sydney Electricity~~ and ~~Prospect Electricity~~ *Energy Australia and Integral Energy*. *Energy Australia* alone has over one million customers.

How electricity is taken to the home

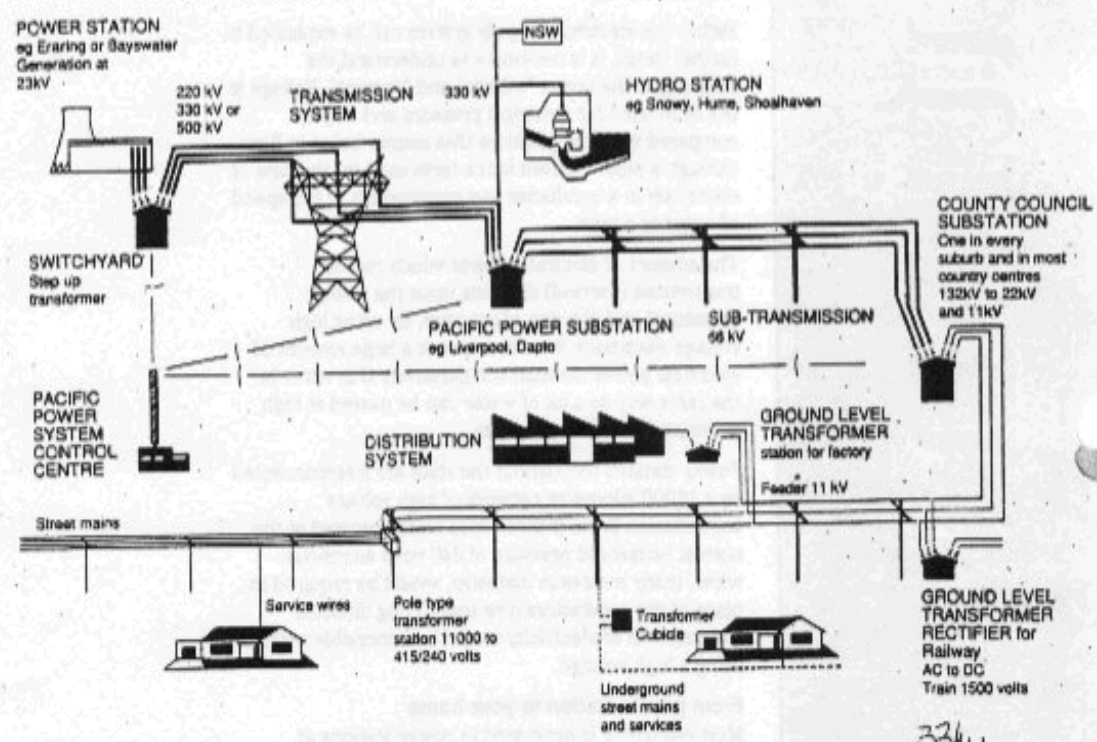

33kV

These transformers are able to "step-up" (increase) the voltage to 330 000 volts and even 500 000 volts, which is about 800 and 1200 times respectively greater than the 240 volt single phase household supply. Thus high voltage helps electricity travel along the wires better.

The extra high voltage transmission system connects the power stations to large substations on the outskirts of the cities and major towns throughout the state. These substations transform the very high voltages down to 66 000 volts and 33 000 volts which is used for the sub-transmission system around the metropolitan area and some country districts. Zone substations have further step-down transformers which lower the voltage to 22 000 or 11 000 volts. Electricity at this voltage can then be transmitted on smaller, lighter power poles, until the supply is finally reduced to 240 volts by small transformers on wood poles or enclosed at ground level. Then the power goes out to homes, factories and offices.

Most houses receive their power supplies from overhead mains (wires) because it is cheaper than underground cables.

In New South Wales it is the responsibility of Pacific Power to operate the huge electricity generators and high voltage power lines. A single control centre at Carlingford in Sydney directs the operation of the state-wide transmission system.

At lower voltages electricity is distributed by 25 supply authorities usually called county councils. In Sydney these are called Sydney Electricity and Prospect Electricity. Sydney Electricity alone has over one million customers.

Energy Australia

Energy Australia and Integral Energy

How electricity is taken to the home

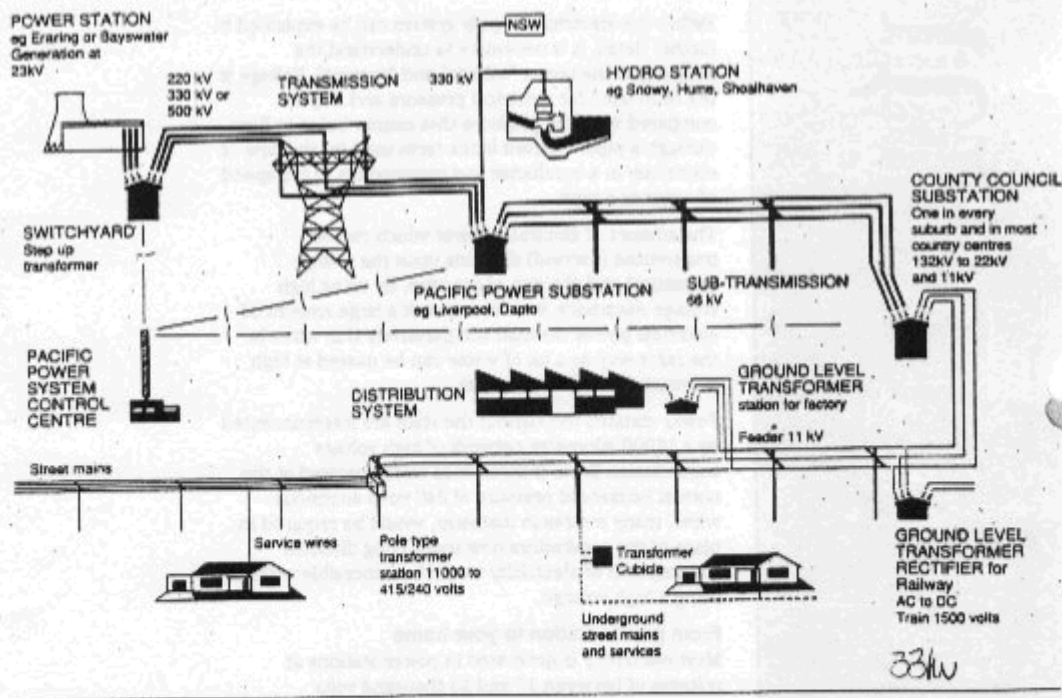

33kw

PROTECTION RELAYS

Protection relays or fault detectors, operate in response to one or more electrical quantities measured on the high voltage system.

If an abnormal condition is detected, then the relay will open or close contacts, to initiate a tripping of a circuit breaker and isolate the fault condition.

There are many different types of protection relays, that may monitor voltage, current, frequency, power flow etc.

There are electromechanical relays, and solid state relays.

Electromechanical relays can be classified by their construction.

Electromagnetic Attraction Relays

Most relays of this type comprise an iron cored electromagnet, that attracts a movable armature which is hinged, pivoted or otherwise supported so as to permit motion in the magnetic field.

The motion is controlled by an opposing force usually due to gravity or to a spring.

The electromagnet is energised by passing current through a coil on the magnetic circuit, and as the magnetic flux density in the core increases, the moving armature is attracted close the magnetic circuit.

The armature is usually a light iron piece, and may carry a moving contact which engages with a fixed contact when the armature operates.

Alternatively, the armature may operate a rod which pushes together two contacts.

The closing contacts will complete a circuit to send a tripping impulse to a circuit breaker.

These relays can be used for both AC and DC quantities.

When energised with AC, the armature will vibrate because the flux will pass through zero twice each cycle, and the armature will be released from the magnetic pole.

To eliminate this effect, a "shading ring" or low resistance copper band is installed on one half of the magnetic core.

The effect of the eddy currents induced into the shading ring, is to produce a second flux which lags the main flux, and ensures that the total flux in the pole does not drop to zero during the cycle of AC.

Alternatively, the AC quantity to be measured, is rectified and applied to the relay as DC which will eliminate the relay vibration.

Refer to FIG 1 which shows the construction of three types of attracted armature relays.

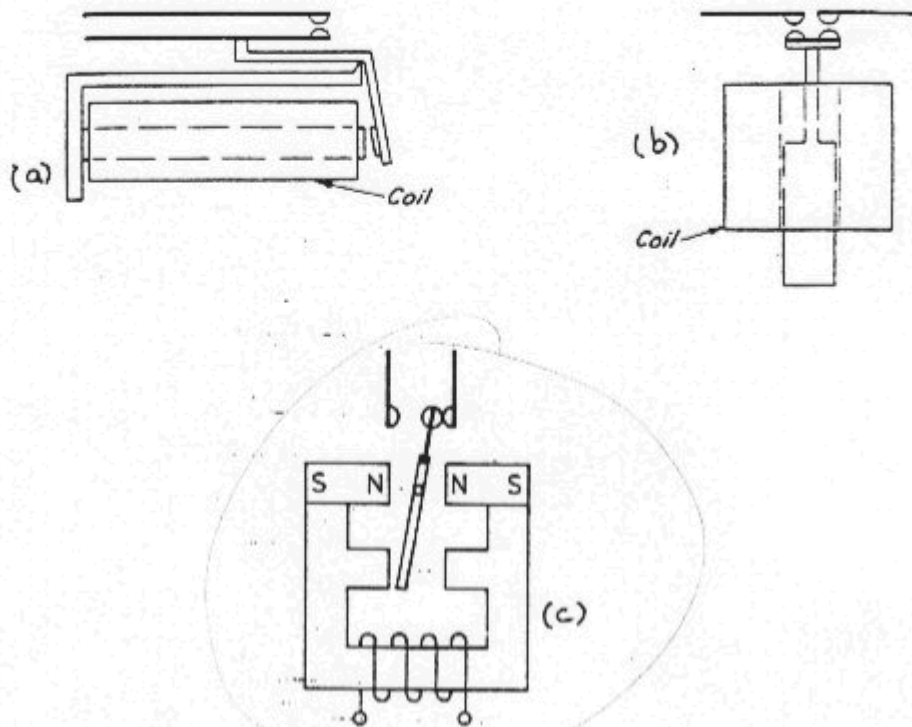

FIG 1

Electromagnetic Induction Relays → INVERSE RELAY, INDUCTION MOTOR

Electromagnetic Induction relays, operate on the principle of the induction motor.

Refer to FIG 2 which shows the arrangement of an induction disc and induction cup relay.

Eddy currents are induced into the rotor of the relay, and torque is produced.

The rotor or moving part of the relay can be a disc, cup or loop.

In the induction disc relay shown in FIG 2, the upper electromagnet induces currents into the disc which will flow in front of the lower electromagnet, which produces a motor action.

Similarly, the lower electromagnet will induce currents into the disc, which will flow past the upper electromagnet and will also produce torque in the disc.

The resulting torque will cause the disc to rotate, and a contact attached to the disc will make contact with a fixed contact to initiate a trip.

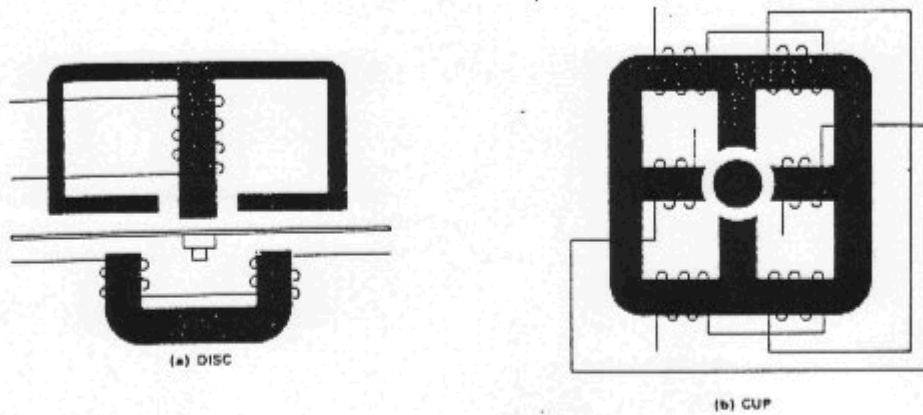

FIG 2

The relays shown in FIG 2 require two input quantities for their operation.

Single Quantity Induction Relays

Torque can be produced in an induction disc relay with a single input quantity.

Refer to FIG 3 which shows an induction disc relay fitted with copper "shading loops", which produce a second lagging flux in the pole face, and thus produce torque in the disc with only one input quantity.

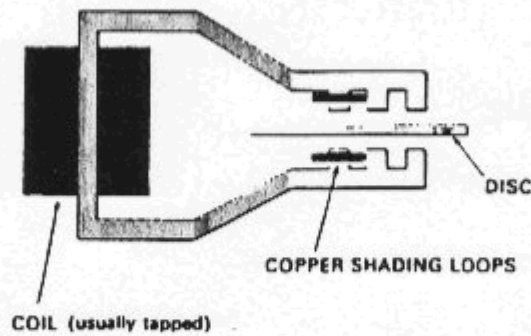

FIG 3

Permanent Magnet Moving Coil Relays

Refer to FIG 4 which shows an axial movement permanent magnet relay.

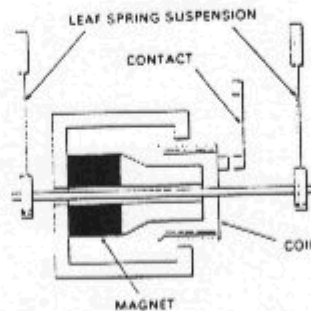

FIG 4

A cylindrical coil is suspended by leaf springs in the field of a concentric permanent magnet system.

The coil is capable of moving axially over a short distance.

The coil is wound on a former which also carries a moving contact.

The moving contact will make contact with a fixed contact if the coil moves in the trip direction.

This relay is a DC relay and its direction of travel will depend on the polarity of the voltage applied to the coil.

The relay would require an AC quantity to be rectified before measurement.

The moving coil is light in weight, and is sensitive and fast operating.

Balanced Beam Comparator

The balanced beam comparator can be used to compare the magnitude of two quantities.

Refer to FIG 5 which shows the arrangement of a Balanced Beam Comparator.

The balanced Beam Comparator has two coils and armatures,

- i) an operate coil which when energised will tilt the beam to close the relay contacts,
- ii) a restraint coil which when energised will tilt the beam to keep the relay contacts open.

2 electro magnets pulling against another
Amplitude comparator

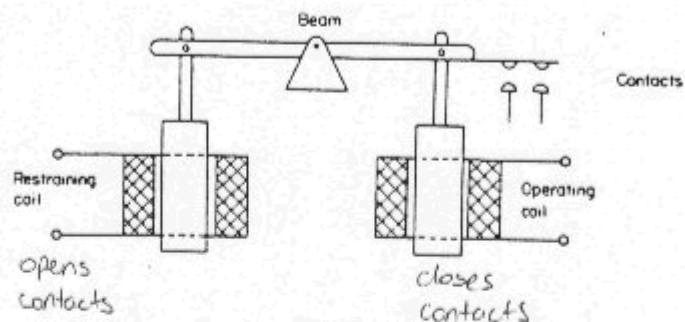

FIG 5

1214

When the two coils are energised simultaneously, if the operate quantity is greater than the restraint quantity, then the relay will close contacts and operate.

If the restraint quantity is greater than the operate quantity, then the relay contacts will remain open and the relay restrains.

Operating Time of Relays

Depending in the design of the relay, the time of operation of a relay (total time from application of measured quantity to closing of trip contacts) will vary from "instantaneous" (no intentional time delay) to "timed" (deliberate time delay applied).

Relays of light construction and in particular DC operated rectifier relays are normally high speed.

Other electromechanical relays such as the induction disc type are slower in operation, although this inherent time delay is used to advantage as is discussed in other notes on "time graded" protection schemes.

Inverse Definite Minimum Time (IDMT) Relay

Refer to FIG 6 which shows the construction of an induction disc relay

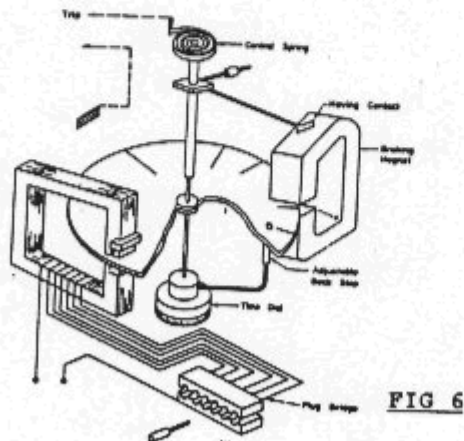

FIG 6

The induction disc relay requires an input quantity to be applied to its coils, develops a turning torque in its disc and when the disc turns, a set of tripping contacts will close.

The relay is called an "inverse" relay because its operating characteristic is an inverse curve as shown in FIG 7.

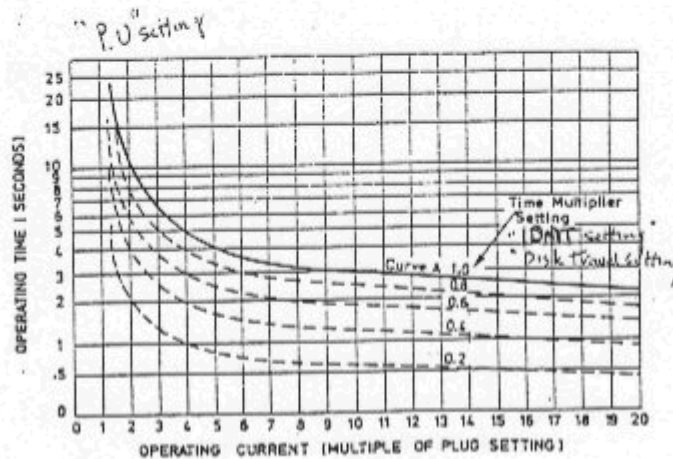

FIG 7

ORIG

The curve is a plot of relay operating time versus current measured, and its shape indicates that the higher the current measured by the relay, the shorter is the operating time of the relay.

However, there is a "minimum" operating time, caused by the saturation of a magnetic circuit in the relay.

There are two main adjustments on the relay, one for the minimum level of measured quantity required to operate the relay (called pickup), and the adjustment of operating time.

The adjustment on the relay to set the minimum current necessary for operation is called pickup adjustment and is achieved by varying the number of turns on the relay coil by a plug position, and also by adjustment of the disc return hairspring.

The operating time of the relay is adjusted by moving the "backstop" of the disc.

This adjusts the distance that the disc must travel before closing contacts.

The IDMT relay provides timed backup to other relays further away from the source, and also provides fast operating time for more severe faults.

OVERCURRENT AND EARTH FAULT PROTECTION

Phase to phase faults and phase to earth faults can be detected by measuring fault current flowing in the HV power system.

Current transformers (CTs) are used to supply an accurate proportion of the system fault current to fault detector relays.

The relays may be instantaneous attracted armature relays or induction disc (IDMT) relays.

Three Phase Overcurrent Protection

FIG 1 shows three relays connected in circuit with three CTs where each relay is measuring the secondary current of a CT.

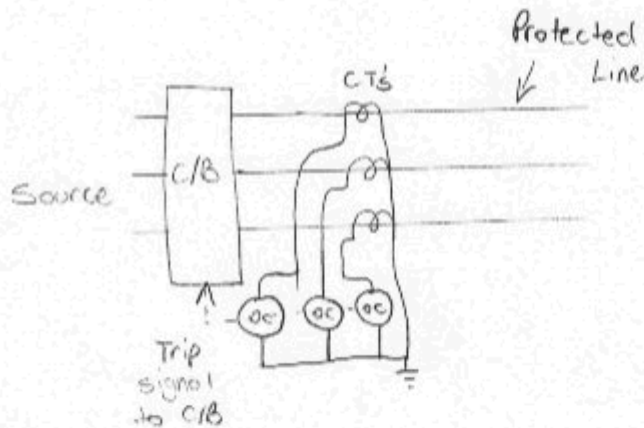

FIG 1

There is a relay measuring current in each phase of the power system, and when each operates, contacts will close and send a signal back to the HV circuit breaker to isolate the fault.

Each relay is adjusted to operate when the current it measures is above full load current on the system, at the point where the current transformers are installed.

The actual relay operating value will depend on the minimum fault level that we want to detect.

This will depend on the arrangement of the power system, which faults we want to detect and how quickly we want to clear the fault.

When a single phase to earth fault occurs, there will be high current flowing in the faulted phase and no current flowing in the other two phases.

FIG 2 shows the primary and secondary currents of the CT and relay current that will flow for a single phase to earth fault.

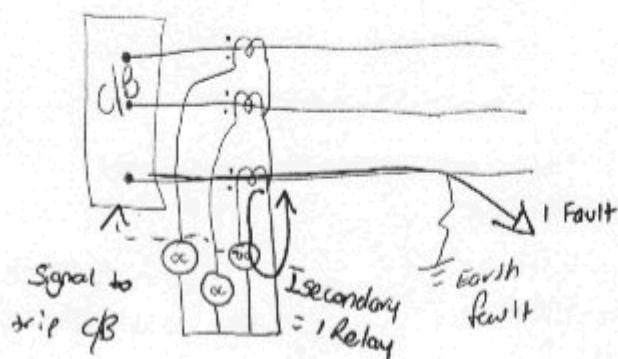

FIG 2

Note that only the relay measuring current in the faulty phase will operate, since the other relays will not measure any current.

Therefore each relay will detect a fault in its phase on the HV system.

FIG 3 shows the primary and secondary currents of the CTs and relay currents that will flow for a phase to phase fault.

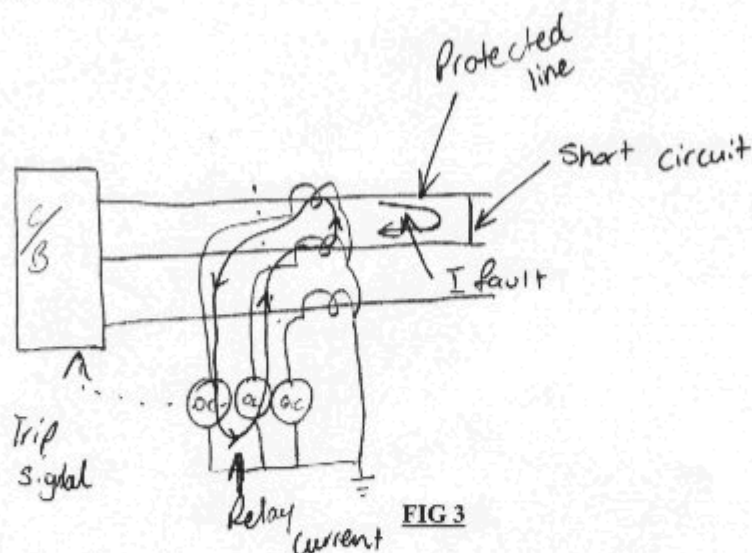

FIG 3

Note that two relays will operate for the phase to phase fault.

The connection of three relays and CTs as shown in FIG 1 will therefore cover any combination of

earth or phase faults, hence the name "Three Phase Overcurrent and Earth Fault Protection".

Detection of Low Level Earth Faults

Sometimes earth faults that occur on HV power systems produce fault current that is less than full load current.

This is possible when the fault is a long way away from the source, or when there is a high value of earth impedance between the point of fault and the source.

If this occurs, the relays in the "Three Phase Overcurrent" circuit of FIG 1 would not operate because they are adjusted to operate at current levels higher than full load current.

Study of fault calculations tells us that earth faults produce zero sequence currents and so earth faults can be detected using a zero sequence detector as shown in FIG 4.

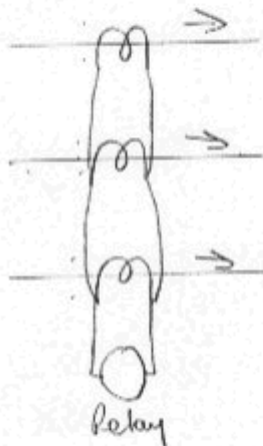

FIG 4

Only zero sequence components of earth fault current will flow in the neutral connection of the CTs and when normal balanced load current flows in the three phases of the HV power system, there will be no neutral current.

This means that the earth fault relay can be adjusted to operate at a low value of current as it does not carry normal load current.

Two Phase Overcurrent and Earth Fault Protection

FIG 5 shows a circuit used to detect phase to phase and phase to earth faults on the HV power system using only three relays.

Any phase to phase fault will be detected by at least one overcurrent relay and any earth fault will be detected by the earth fault relay which can have a low setting.

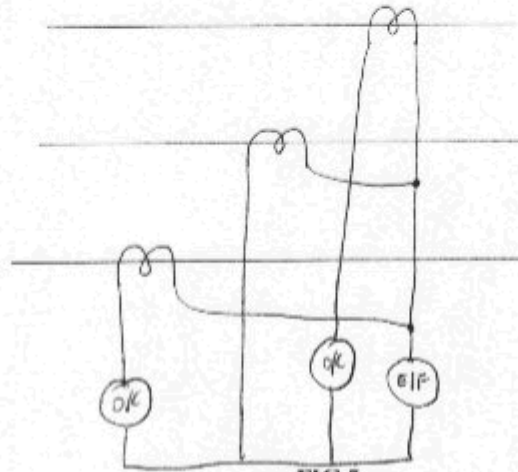

FIG 5

The pickup value of the relays and their operating times will be determined by the location of the fault to be detected and the severity of the fault and the required clearance time.

This is discussed in other notes entitled "Grading of Overcurrent Protection".

DIRECTIONAL OVERCURRENT PROTECTION

The attracted armature or induction disc overcurrent relay in its basic form is non-directional.

This means that the relay can only measure the magnitude of the current and cannot determine the direction of power flow.

By adding a directional element to an overcurrent relay, the relay can be made to operate for only one direction of power flow, and ignore the other direction.

Refer to FIG 1 which shows phasor relationships between phase voltages and currents for power flow out of the substation and into the substation.

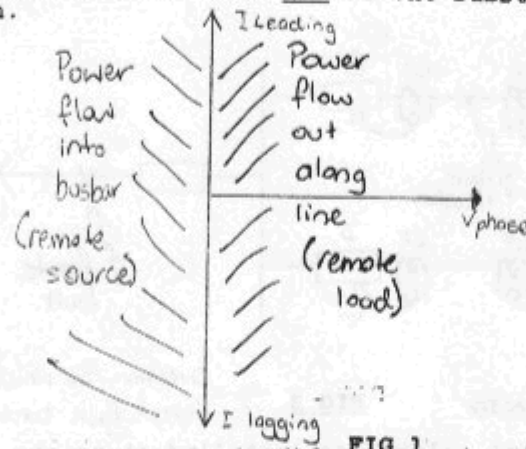

FIG 1

ORIG

Normally it would only be necessary to trip a circuit breaker when fault current was flowing out along the line and not trip if power was flowing back into the substation.

Refer to FIG 2 which shows a circuit breaker trip circuit where it is necessary for both overcurrent and directional relays to operate simultaneously before a CB trip will be initiated.

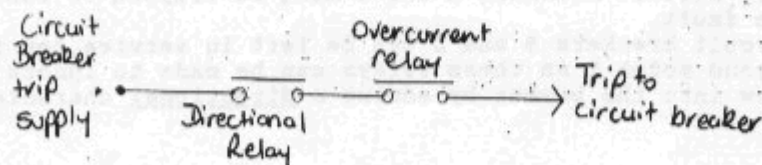

FIG 2

ORIG

Note: An alternative to the series connected contact arrangement shown above, is to have the directional relay, control the operation of the overcurrent relay. This means that there must be correct direction of current flow before current magnitude is measured.

Power can only flow back into the substation busbar from the line, if there is a power source at the other end of the line.

This means that directional overcurrent protection would not be necessary on radial feeders where there is no possibility of a backfeed.

But a directional characteristic would be required at certain points in parallel feeder arrangements, ring mains and interconnected multi-source power systems.

Directional Overcurrent Relays Applied to Parallel Radial Feeders

Refer to FIG 3 which shows an arrangement of two parallel radial feeders.

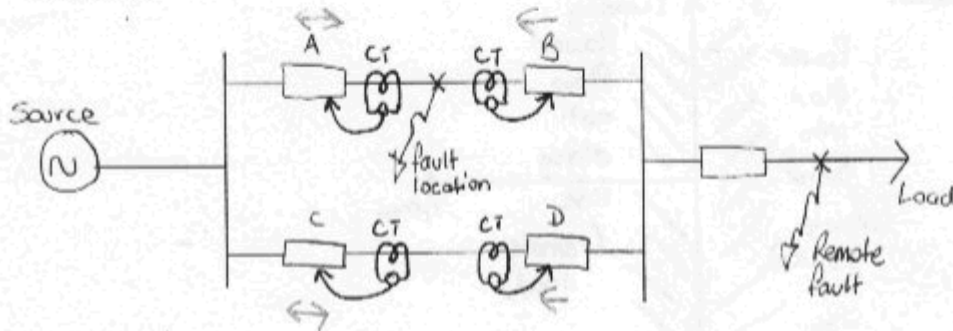

□ = Circuit Breaker

FIG 3

→ Direction in which CT will ORIGINALLY detect fault current and trip.

Notes:

Non-directional relays are installed at points A and C, because power will only flow out along the line at these points.

At points B and D it is possible for power to flow back around the loop for a fault either between A and B (at point F₁) or between C and D (at point F₂).

For a fault at point F₁, circuit breakers A and B must trip to completely isolate the fault.

For a fault beyond Y that is not correctly cleared at Y, only circuit breakers A and C must be tripped to isolate the fault.

Circuit breakers B and D can be left in service for faults beyond point Y so these relays can be made to ignore current flow into the busbar by adding a directional characteristic.

Directional Overcurrent Relays Applied to Ring Main Feeders

Refer to FIG 4 which shows an arrangement of a single source ring main feeder system

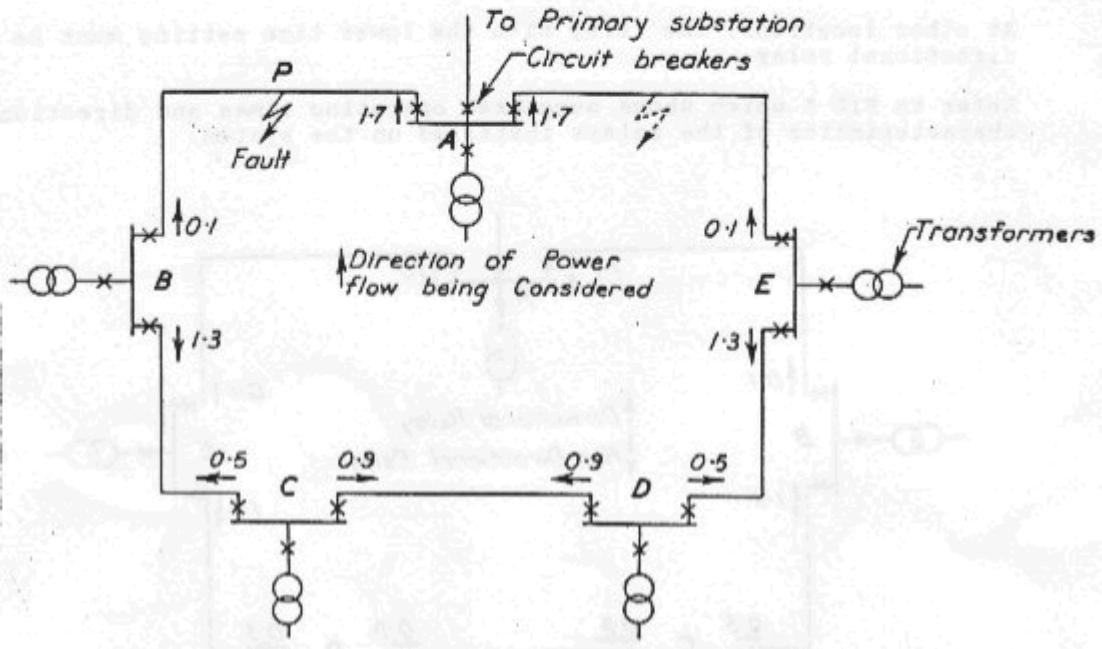

FIG 4

DUA623

If a fault occurs on any section of line, two circuit breakers (one on either side of and adjacent to the fault) must be tripped to completely isolate the fault.

The system can be considered as two radial feeders when calculating time grading.

Where fault power is fed from either end of the ring, the circuit breaker nearest the fault must trip first.

The arrow directions shown on FIG 4 indicate the desirable direction of power flow for tripping of each breaker and the corresponding graded tripping time.

Assume a fault occurs on feeder AB at point P, the circuit breaker controlling the feeder at B would be tripped instantaneously (say 0.1 sec).

Tripping times at C, D, E and A would progressively increase by margins of say 0.4 sec for time grading.

The same delays would apply when working in the opposite direction for a fault on feeder AE.

Not all relays used on this system need to be directional.

The relays at the primary substation can be non-directional, because power can only flow away from the busbar at those locations.

At other locations, the relay with the lower time setting must be a directional relay.

Refer to FIG 5 which shows suggested operating times and directional characteristics of the relays installed on the system.

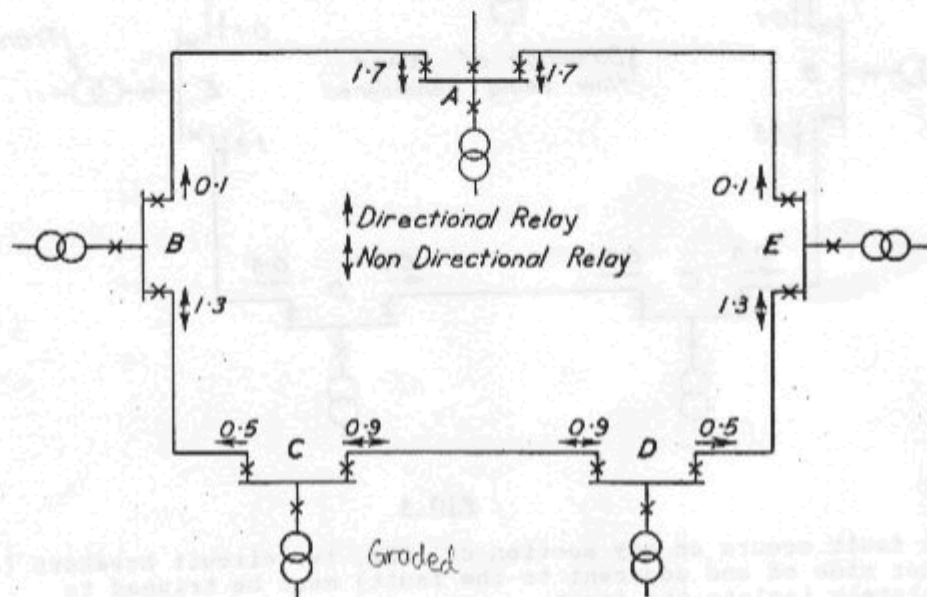

FIG 5

DUA6¹¹

Directional Overcurrent Relays Applied to Interconnected Power Systems

In multi-source EHV interconnected power systems, overcurrent protection is not used because its response time is too long.

However, the problem of identifying direction of power flow still exists, and directional characteristics are added to "unit" type protection schemes which have faster operating times. (Refer to other notes on Transmission Line Protection)

GRADING OF OVERCURRENT PROTECTION

Overcurrent protection applied to HV equipment, is designed to detect excessive current flowing, and send a tripping impulse to the controlling circuit breaker to disconnect the fault as quickly as possible.

There are two basic types of overcurrent relay.

a) **Instantaneous Overcurrent Relay (IOC)**

Relays of this type include electromagnetic attraction design, which will operate instantaneously (no deliberate time delay) when the operating current is applied to their coils.

b) **Inverse Definite Minimum Time Relay (IDMT).**

Relays of this type include the electromagnetic induction disc design, whose operating time will vary, depending on the magnitude of the current applied and the setting of the relay.

Notes: These relays can only measure the magnitude of current, and cannot determine the direction of the current flow.

However, they can be made into directional overcurrent (DOC) relays by the addition of a directional characteristic.

Standard relay rated currents are 1 amp and 5 amps.

Setting of Overcurrent Relays

Pickup Current

"Pickup" current is the minimum value of current that can be applied to the relay, to cause it to operate and close the trip contacts.

Instantaneous Relay Setting

IOC relay pickup is determined by the plug setting on the relay, which selects the number of turns on the operating coil and the mechanical adjustment of control springs.

This controls the level of current at which the relay armature is attracted and the contacts will close.

Provided the current applied to the relay is \geq the pickup current, the relay will operate "instantaneously".

IDMT Relay Setting

The setting of an IDMT relay is determined by the following two points on its characteristic curve.

- a) "Pickup" is the minimum current that would cause the induction disc to turn and close contacts.

Pickup is adjusted by means of selecting tapings on the main operating coil, which will vary the torque produced on the disc.

Tapings may vary the pickup from 50-150% of the rated current of the relay. (Ex: 0.5-1.5A for a 1amp relay)

- b) "Definite Minimum Time Point" is the minimum time taken for the relay to close its contacts.

The definite minimum time is reached at 20 times the "pickup" current.

The current required for the definite minimum time would be 20 amps for a 1 amp relay, and 100 amps for a 5 amp relay.

Refer to FIG 1 which shows the two setting points on the relay inverse characteristic curve.

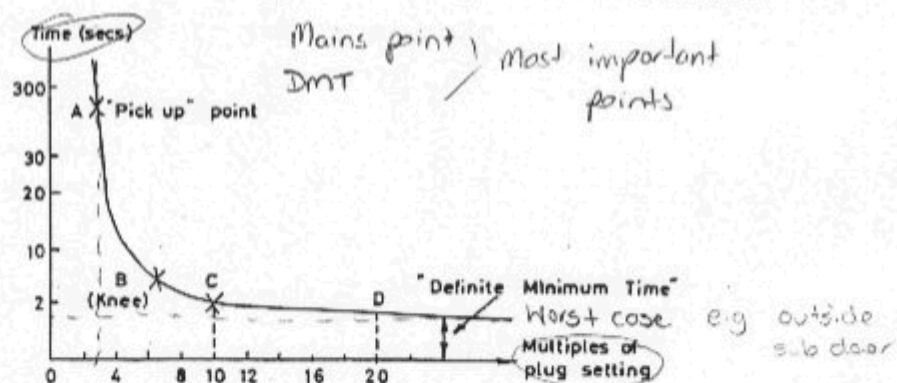

FIG 1

The definite minimum time point on the relay curve, is adjusted by increasing or decreasing the gap between the fixed and moving contact of the relay.

This is called the "time lever" or "time multiplier" adjustment and changes the position of the disc, giving it a shorter or longer distance to travel before closing contacts.

The time adjustment has the effect of moving the characteristic curve in the vertical direction.

Once the pickup and the definite minimum time points are set, the rest of the points on the relay characteristic are determined by its design and cannot be adjusted at will.

IDMT relays are designed with different shaped curves as shown in FIG 2.

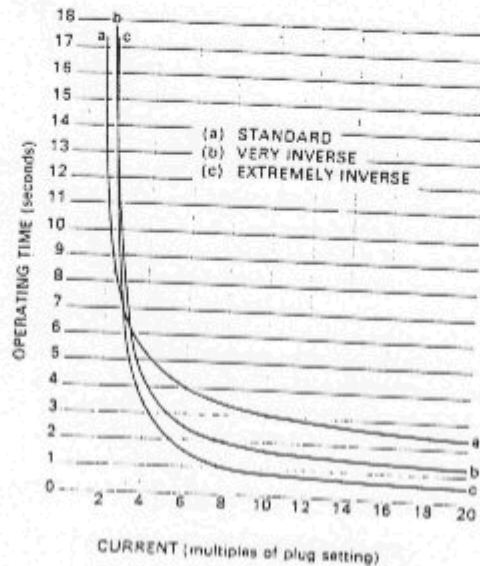

FIG 2

PRAG617

IDMT relay settings are written in the following way:

Example: 5 amp relay 125/40/100

125 = pickup setting, where current of 125% of relay rated current (125% of 5 amps = 6.25A) is applied to relay.
125% of rated current

40/100 = DMT setting, where relay set to close contacts in 40 cycles (0.8 sec) when 20 times rated current (100A) are applied to relay.

Note: It is sometimes more convenient to give a setting point on the curve at some value of current other than the DMT point.

However, the setting of the pickup point and another point will still fix the curve position.

Grading Between IDMT Relays

Grading is the adjustment the settings of a number of protection schemes that may respond to the same fault condition, so that the most appropriate scheme operates and trips the fault first.

This means that a number of schemes may be installed to provide backup if the primary protection scheme fails to clear the fault.

Schemes using overcurrent relays for detection are simple, and are usually "unrestricted zone" schemes which are not very discriminating.

This means that if a number of relays are installed at different positions on the power system, their settings must be adjusted so that:

- a) the most appropriate relay operates first and
- b) other relays provide backup in the event of failure of any relays to operate.

The types of grading possible when using overcurrent relays are:

- i) **Time grading** is most commonly applied to overcurrent protection, where a series of current sensitive relays are installed on a HV system.

Refer to FIG 3 which shows an arrangement of radial HV lines with overcurrent protection installed at the supply end of each line.

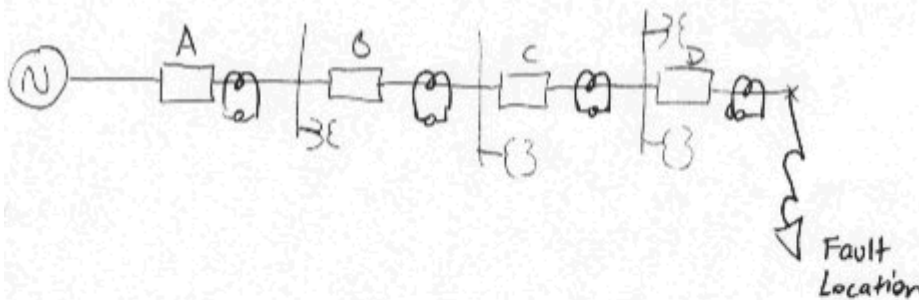

FIG 3

ORIG

If a fault occurs at point X on the last section of line, then the fault should be isolated by tripping circuit breaker D, thus isolating the minimum part of the HV system.

However, if the fault fails to clear at D, then the next line of defence is to isolate at point C.

Time grading is applied to the detector relays at points A, B, C and D by increasing the operating time back towards the source end of the system.

This means that relay D is backed up by relay C then relay B and finally relay A.

The **disadvantage** of time grading, is that the relay closest to the source at point A, is protecting the first section of line between A and B, where the fault level is greatest, but this relay has been given the longest operating time.

This is undesirable, since the philosophy of protection is that faults should be isolated as quickly as possible.

- ii) **Current Grading** of overcurrent protection relies on the fact that the fault current varies with the position of the fault because of the difference in impedance values between the source and the fault.

Typically, the relays controlling the various circuit breakers, are set to operate at different values so that only the relay nearest the fault trips its breaker.

Refer to FIG 4 which shows a radial system with current discrimination.

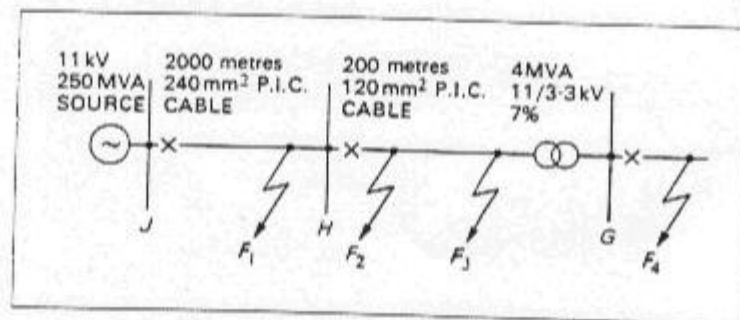

FIG 4

PRAG92

The relay controlling the circuit breaker at point J will be set to operate for any fault current between J and H, and will cover for a fault at point F_1 .

However, a fault at point F_2 will draw nearly as much current as fault F_1 because the distance between F_1 and F_2 is small and the impedance difference is minimal.

In practice there would be variations in the source fault level, and it is possible that the relay at point J would operate for a fault beyond point H and incorrect tripping would occur.

Discrimination by current is therefore not practical between J and H, but could be achieved between H and G due to the large impedance in the transformer.

The **disadvantage** of the current grading method, is that there must be an appreciable impedance between two circuit breakers otherwise discrimination is not possible.

This problem is resolved by using IDMT overcurrent relays which have "inverse" characteristics where their operating time decreases as the current applied to them increases.

iii) **Time/current grading** of overcurrent protection is where IDMT relays are installed on the power system.

If the relays shown in FIG 3 had IDMT characteristics, then the relay installed on the HV system at point A, would have a long operating time for a fault at point X since the fault level is low.

Whereas a severe fault occurring between A and B would result in more current applied to the relay and its operating time would be shorter.

Thus the IDMT relay provides timed backup to other relays further out, and also provides fast operating time for more severe faults in its own area of interest.

Relay Grading Margin

The time interval between the operation of two adjacent relays depends on a number of factors.

- i) the fault current interrupting time of the circuit breaker,
- ii) the overshoot time of the relay,
- iii) errors in relay and current transformer ratio and phase angle,
- iv) final safety margin on completion of the operation.

A typical time grading margin, would be 0.4 seconds.

Discrimination by both Time and Current

Example: Refer to the power system shown in FIG 5.

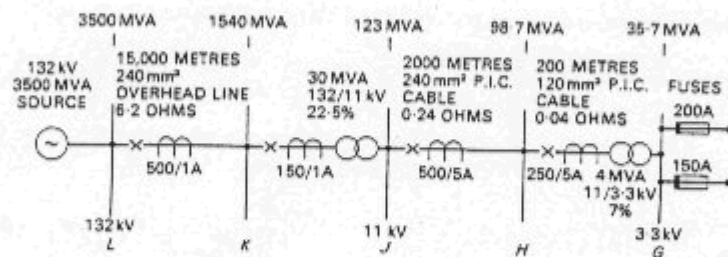

FIG 5

PRAG93

IDMT relays are installed at points H, J, K and L so that minimum operating time is achieved for the maximum fault level that each relay must detect, and at the same time, grade with the other relays and the fuses.

Refer to FIG 6 which shows the characteristics of the fuse and relays installed on the system.

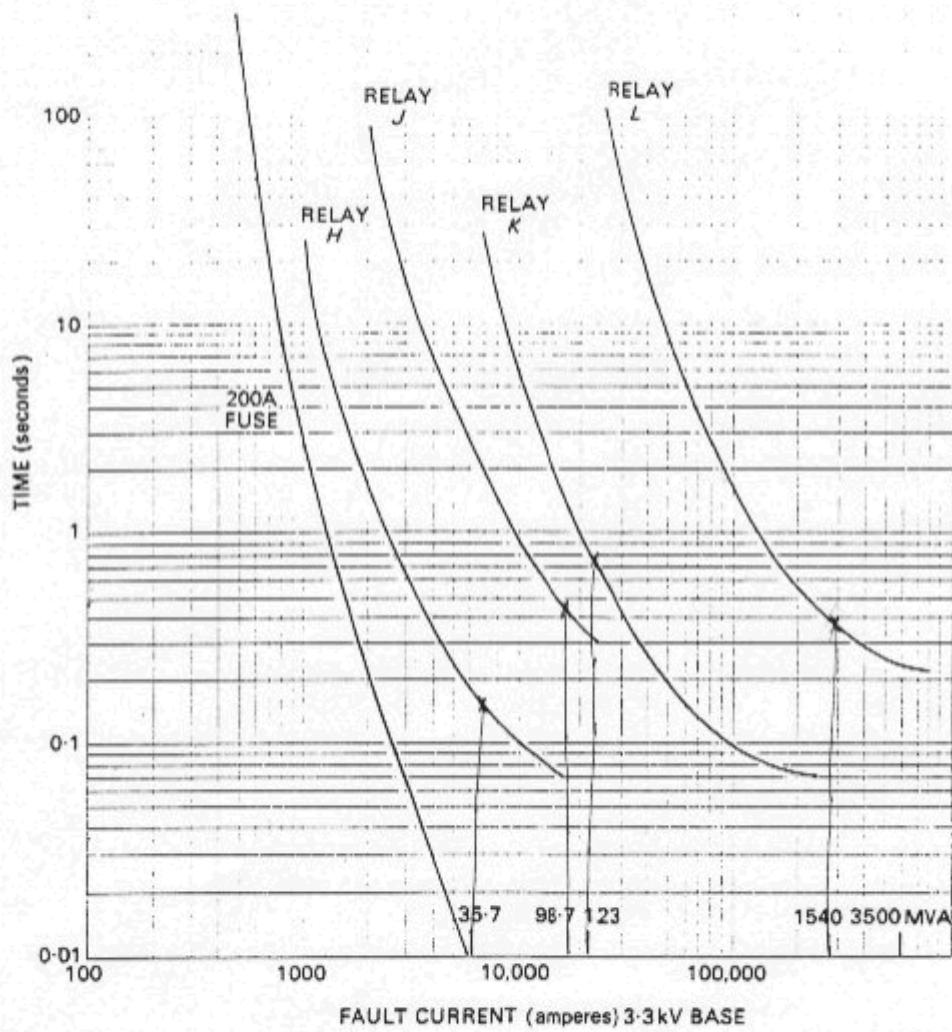

FIG 6

PRAG93

POWER TRANSFORMER PROTECTION

The power transformer is one of the most important links in the power supply system.

The large power transformer is very expensive, but is relatively simple in construction, and is a highly reliable piece of equipment.

The high cost of repair or replacement requires the transformer to be protected against damage arising from internal faults or from external overloads.

Protective equipment includes surge diverters, gas relays and electrical relays.

Gas relays are particularly important because they give early warning of a slowly developing fault, permitting shutdown and repair before serious damage can occur.

Types of Transformer Faults

Through Faults

A through fault is not in the transformer, but is located on the power system external to the transformer.

Although faults of this type are not in the transformer, they can cause damage to the transformer due to the large fault currents passing through the windings or sustained overload conditions.

They must be cleared by other protective equipment installed at the point of fault, before the transformer is disconnected.

If the appropriate protection equipment does not clear the fault externally, then the transformer must be isolated.

External short circuit conditions can be detected by overcurrent relays measuring current in the transformer windings.

These overcurrent relays would be time delayed to allow the external protection to operate first.

Sustained Overload Conditions

An overload condition, is described as a transformer loading in excess of the kVA or MVA rating of the transformer.

This condition may not be caused by a short circuit, but may result from the transfer of additional load to the transformer, after the disconnection of another source or transformer sharing the load.

Short time overloads are normally accepted by the transformer, but sustained overloads will cause the transformer windings to overheat, causing damage to the windings and insulation.

Overload conditions can be detected by thermal relays which monitor the temperature of the transformer oil and/or windings.

Internal Faults

Internal faults in transformers occur within the transformer protected zone, are usually very severe and there is the risk of serious damage to the transformer and the possibility of fire.

Internal faults can be classified into two groups:

Group 1: Electrical faults which cause immediate serious damage but are generally detectable by unbalance of voltage or current such as:

- a) Phase-Earth or Phase-Phase fault on HV or LV external terminals,
- b) Phase-Earth or Phase-Phase fault on HV or LV windings,
- c) Short circuit between turns of HV or LV winding,
- d) Earth fault on a tertiary winding or short circuit between turns of a tertiary winding.

Group 2: "Incipient" faults which are initially minor faults, causing slowly developing damage, but are not detectable at the winding terminals by unbalance and include:

- a) poor electrical connection of conductors, core faults due to breakdown of insulation on laminations, bolts or clamping rings, all of which cause limited arcing under the surface of the oil and generation of gas,
- b) coolant failure which will cause a rise in temperature even below full load operation,
- c) loss of cooling oil or clogged oil flow, which will cause local hot spots on the windings,
- d) voltage regulator faults and bad load sharing between transformers in parallel, which can cause overheating due to circulating currents between the transformers.

Generally for Group 1, it is important that the faulted equipment should be isolated immediately after the fault has occurred.

The faults in Group 2, although not serious in their initial stage, may cause major faults if allowed to continue for any long period of time.

Group 2 faults should be cleared as soon as possible after detection, and the cause investigated.

The protective devices designed to detect faults in Group 2, are reasonably simple, and are generally one of two types:

- a) thermal devices,
- b) gas actuated devices.

Transformer Thermal Protection

Hot Oil Relay Device

A Hot Oil relay is a contact making thermometer, which directly measures the transformer oil temperature.

It is not considered to be a satisfactory overload or fault protective device, because the thermal time constant of the oil is much greater than the windings, during the passage of heavy short period overloads.

The winding temperature may reach a dangerous destructive level before the total oil temperature rises sufficiently for the thermometer to close contacts.

Oil temperature thermometers with or without alarm contacts, are however, provided on large transformers so that the overall temperature of the transformer can be monitored.

This is essential where high ambient temperatures occur or where it is necessary that the cooling system be monitored.

The relay contacts can be connected to initiate an alarm or trip the transformer if the oil temperature should reach the preset value.

Refer to FIG 1 which shows a contact making thermometer device.

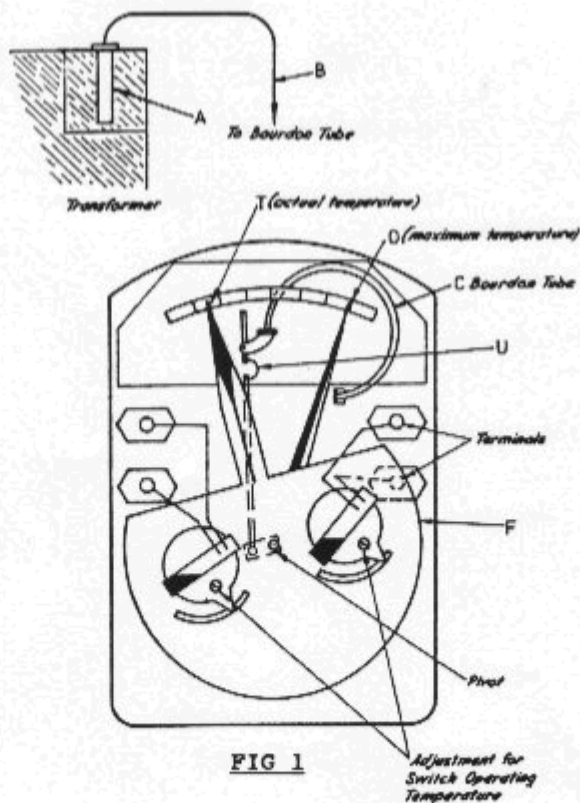

ORIG

The oil temperature relay is operated via a mercury filled capillary tube from a thermometer bulb placed in an oil filled cavity at the top of the transformer tank.

The capillary tube is connected to the Bourdon tube on the device.

A temperature rise of the oil in the cavity causes the mercury in the bulb to expand, this expansion being transmitted to the Bourdon tube by the capillary tube.

The circular Bourdon tube will attempt to straighten out under the increased internal pressure of the mercury.

The connecting rod between the Bourdon tube and the mercury switch carrier will cause the mercury switches to operate and the indicating pointer to move upscale.

The mercury switches can be adjusted to close and open contacts at various temperatures, and the pointer indication can be calibrated.

The mercury switches are adjusted to initiate a "Hot Oil" alarm or to trip the transformer.

The relay calibration is checked by removing the thermometer bulb from the cavity and placing it in a bucket of transformer oil, the temperature of which can be controlled by an electrical heater.

Typical settings for a Hot Oil relay on a 132/33kV transformer are:

Alarm: 80°C Trip: 95°C.

Hot Winding Relay Device

As already indicated, a Hot Oil relay will not operate fast enough to prevent damage to transformer windings during heavy short period overloads.

A "Hot Winding" device which immediately senses an overload condition, is desirable.

A "Hot Winding" relay, is identical to the Hot Oil device as previously described, except that in addition to placing the thermometer bulb in a bath of oil, a heater element supplied by a current transformer is wrapped around the bulb.

Thus a rise in current in the transformer windings, is immediately sensed and the relay can be thermally matched to the characteristics of the transformer windings.

Additional mercury switches can be installed to start oil pumps running or start fans running as required in an attempt to reduce the temperature of the transformer.

Typical settings for a Hot Winding relay on a 132/33kV transformer are:

Start Fans and Pumps: 85°C Stop Fans and Pumps: 65°C
Alarm: 100°C Trip: 110°C.

Transformer Gas Actuated Relays

Faults inside oil immersed electrical equipment will generate gas.

Depending on the severity of the internal fault, either small or large quantities of gas will be generated.

Slow generation of gas will cause bubbles to rise to the top of the transformer tank.

A large generation of gas will cause a surge of oil from the top of the transformer tank through the connecting pipe to the conservator tank.

If a fault occurs within a sealed space such as a tapchanger box, then a gas pressure will be created, which could cause an explosion.

There are two basic types of Gas Actuated relays:

- a) Buchholz Relays,
- b) Gas impulse Relays.

Buchholz Relay

The Buchholz Relay consists of a Cast Iron or Bronze chamber, placed in the pipe connecting the transformer tank to the conservator tank as shown in FIG 2.

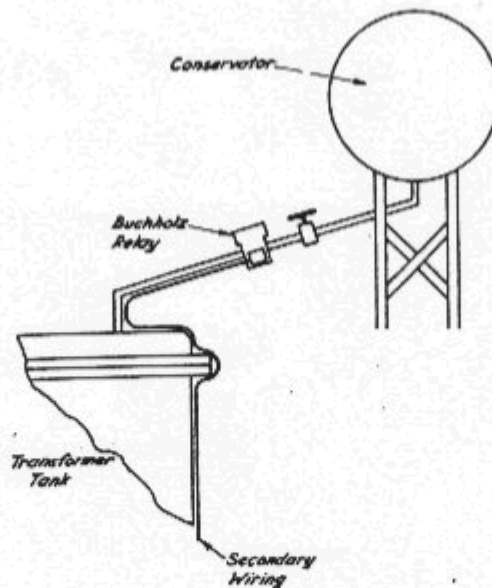

FIG 2

ORIG

The chamber contains two hinged floats, one in the upper part of the chamber and the other in the lower part of the chamber, as shown in FIG 3.

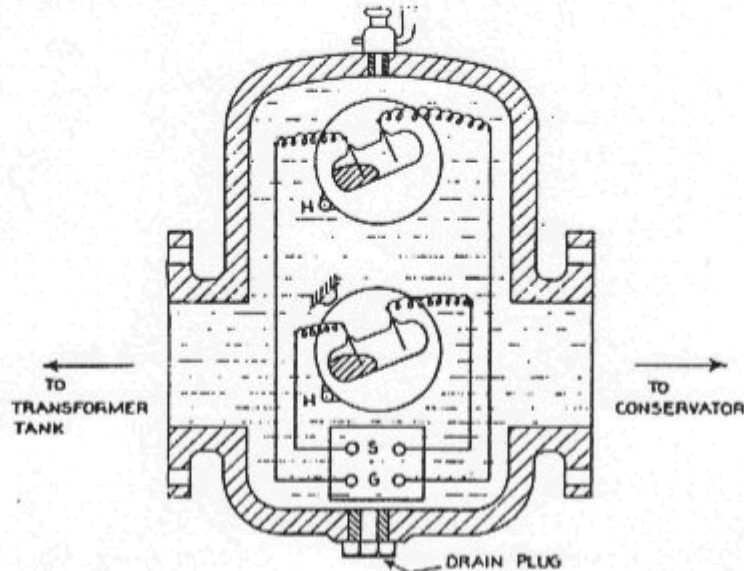

FIG 3

ORIG

A slow generation of gas in the transformer will allow gas bubbles to travel to the top of the transformer tank, up the pipe towards the conservator tank and become trapped in the upper part of the Buchholz chamber.

The upper hinged float has a mercury switch attached to it, and if sufficient gas accumulates in the chamber, the float will drop closing the mercury switch contacts and initiating an alarm.

The lower float switch has an adjustable flap attached to it, which is exposed to the flow of oil from the transformer tank to the conservator tank.

If large quantities of gas are generated, then oil rushes through the Buchholz relay, hitting the exposed flap and causing the float to drop and the attached mercury switch to close contacts.

This mercury switch is connected to initiate a trip of the transformer circuit breakers.

The sensitivity of the flap can be adjusted by exposing a larger or smaller area of the flap to the flow of oil.

The two float switches can also detect a loss of oil from the transformer as the oil level drops in the Buchholz relay.

They can be made to initiate a "low oil alarm" or "low oil trip".

Gas Impulse (Pressure) Relays

There are two types of Gas Impulse relays, which both use a diaphragm for their operation.

They are installed in tap changer tanks to detect a rise in internal pressure due to fault conditions.

Type 1: Combined breather/pressure switch type, which under normal conditions, and during normal heating cycles, acts as a breather. The relay is above the oil level in the tank, and should the air flow exceed a particular rate, the diaphragm will distort and close contacts.

Refer to FIG 4 which shows the arrangement of a breather type pressure switch.

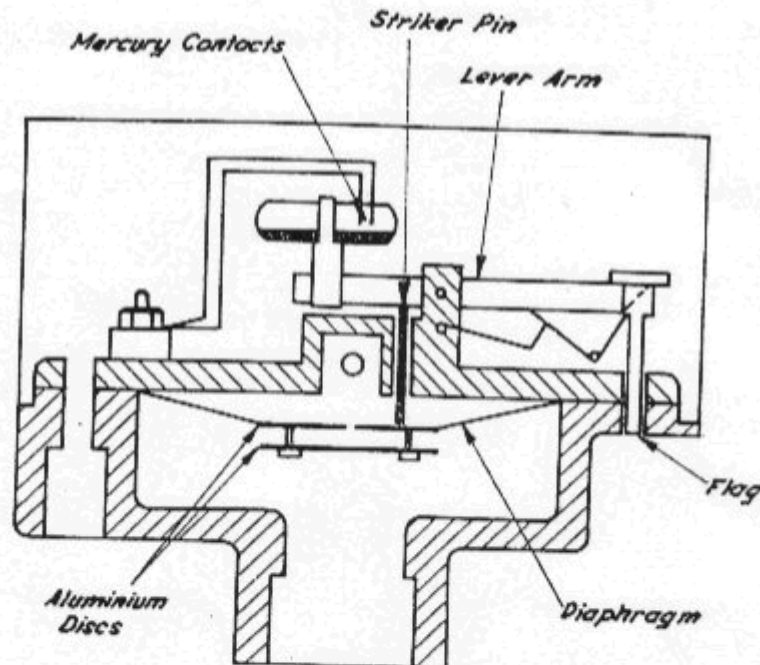

FIG 4

ORIG

Type 2: A totally immersed pressure diaphragm device as shown in FIG 5.

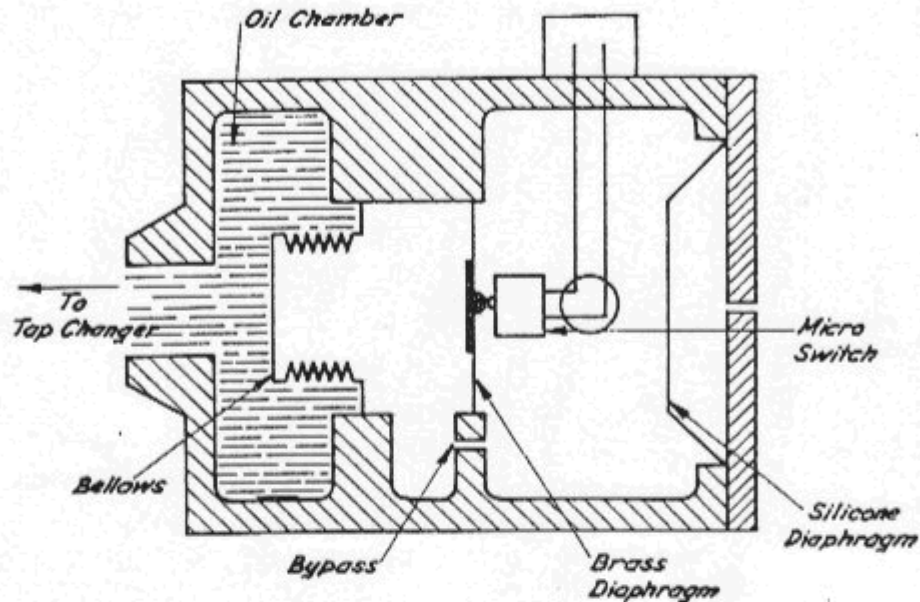

FIG 5

ORIG

For a serious internal fault, pressure builds up in the chamber, compressing the bellows, which applies pressure to the diaphragm, which distorts and closes the micro-switch contacts.

The contacts are connected to trip the transformer circuit breakers.

The protection methods described above, to detect Group 2 faults, are not capable of detecting external faults in Group 1 and would be too slow to clear the severe internal faults in Group 1.

However, they do complement the fast operating protection schemes installed to detect and clear severe internal transformer faults.

Electrical methods of fault detection are required to detect and isolate severe internal electrical short circuits in power transformers.

Differential Protection can be used on transformers and provides high speed (instantaneous) tripping.

Transformer Differential Protection

Differential Protection is a restricted zone scheme, which can be made instantaneous in operation when a fault is detected in the protected zone.

Refer to FIG 6 which is a single phase equivalent of a differential scheme applied to a power transformer.

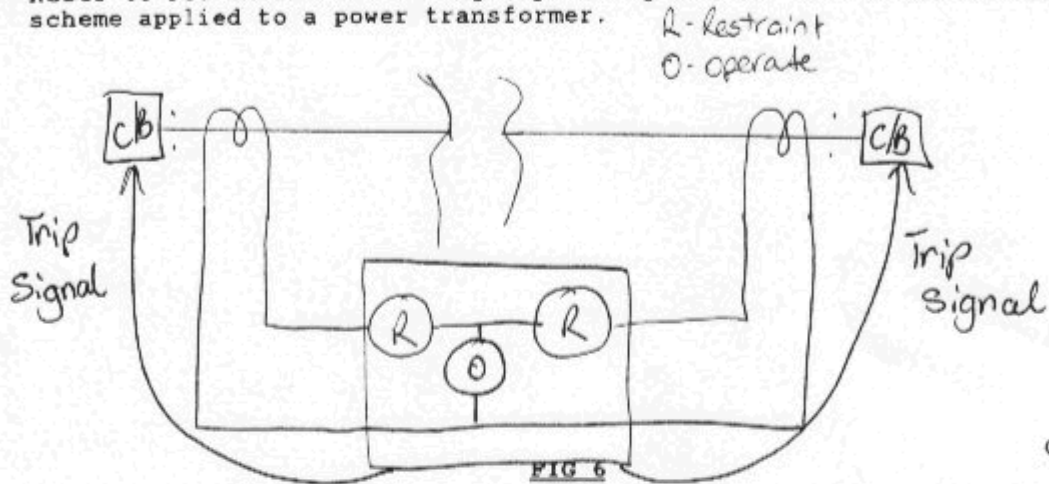

The scheme is a circulating current differential circuit, and the single relay has one operate coil measuring out of balance current and two restraint coils measuring circulating current.

The restraint coils ensure stability of the relay for small out of balance caused by:

- a) CT mismatch,
- b) transformer tapchanger position.

For a genuine internal fault conditions, there will be a large out of balance current causing relay operation.

"Biassed" Differential Relay

Transformer Differential schemes use "Biassed" differential relays for fault detection.

The relay is called a "biased" relay because the restraint current tends to prevent operation or "bias" the relay away from operation.

| |
|---|
| $\text{Percentage Bias} = \frac{\text{operate current}}{\text{mean restraint current}}$ |
|---|

Usually relays have % bias settings of 10, 20, 30 or 40%, to ensure that the relay will not operate unnecessarily due to CT mismatch or the tapchanger position.

Large Out of Balance in Transformer Differential Circuits

Other than genuine fault conditions, large out of balance can occur in transformer differential circuits for the following reasons.

1. Main Transformer Ratio

There will be very different currents on each side of the transformer under normal conditions due to the transformation ratio.

Example: 132/33kV star/star transformer has current ratio 1:4.

This extreme difference in currents would give large out of balance currents in the differential circuit unless it was compensated for by choosing appropriate CT ratios.

Example: 132/33kV transformer in the example above would require say 500/1 CTs on 132kV side and 2000/1 CTs on the 33kV side to give equal CT outputs under balanced or no fault conditions.

2. Main Transformer Vector Grouping

The connection of the primary and secondary windings of the transformer in either Star or Delta, can produce a phase shift between the primary current and secondary current.

The choice of connections and resulting phase shift is called a "vector grouping".

Examples: Yy0, Dd0, Dyll, Ydll, Dyl, Ydl etc.

Although the ratio of the transformer can be compensated for by choice of CT ratios, the phase shift due to vector grouping is cancelled by connecting the CTs in the opposite vector grouping.

Example: Dyl transformer uses Ydll connection of CTs.

3. Magnetising Inrush Phenomenon

When a power transformer is energised from one side, with no load connected to the other side, only one side of the transformer will have current flowing.

This means that only one set of CTs will have an output, and there will be an unbalance in the differential circuit causing relay operation under no fault condition.

The inrush current only lasts for a short time, and contains a large proportion of Second Harmonic components (100Hz).

It is necessary to have extra restraint applied to the differential relay during this time, to prevent unnecessary operation.

This extra bias is called "Harmonic Bias" and is achieved in a number of ways but usually by using a tuned circuit to extract or reject the harmonic components.

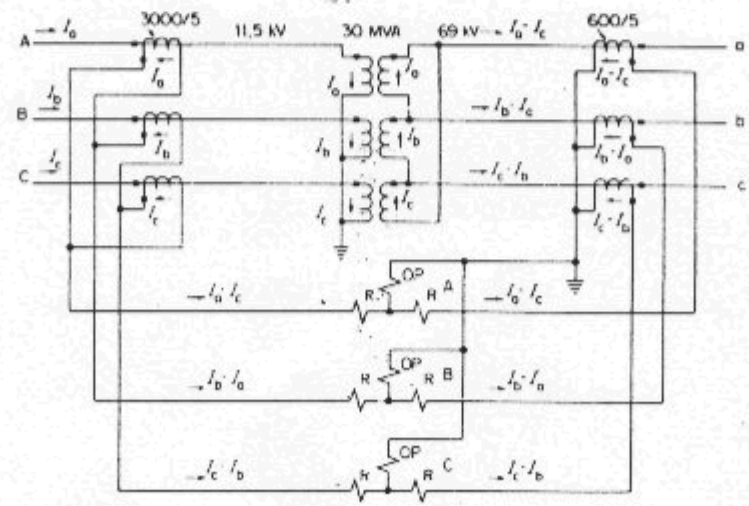
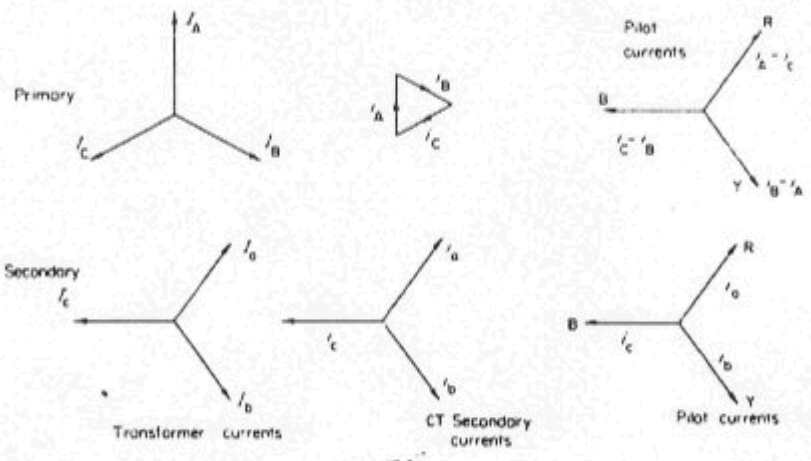
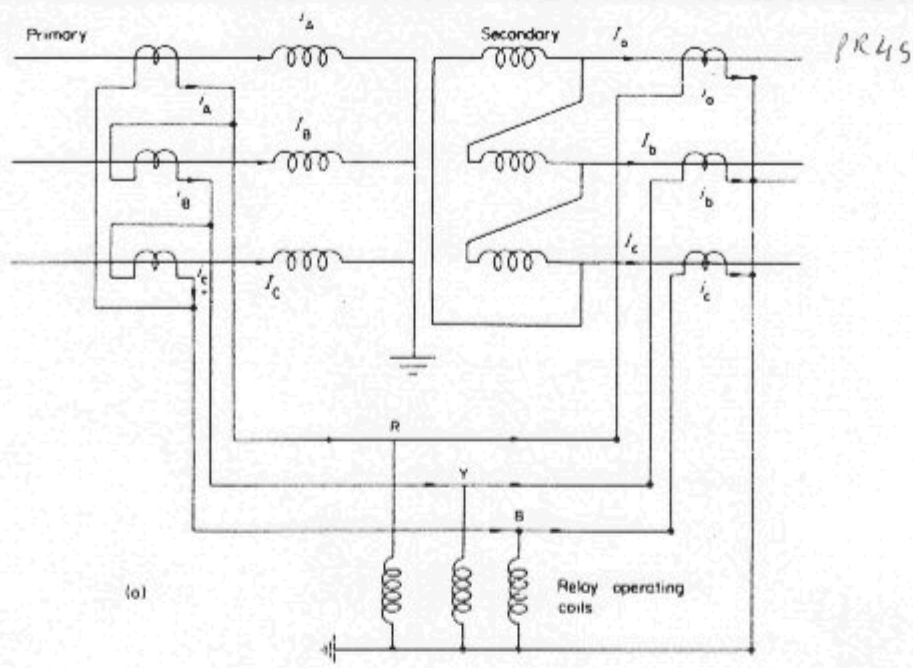

Currents in Y-Δ transformer differential protection.
OP = operating coil, R = restraining coil.

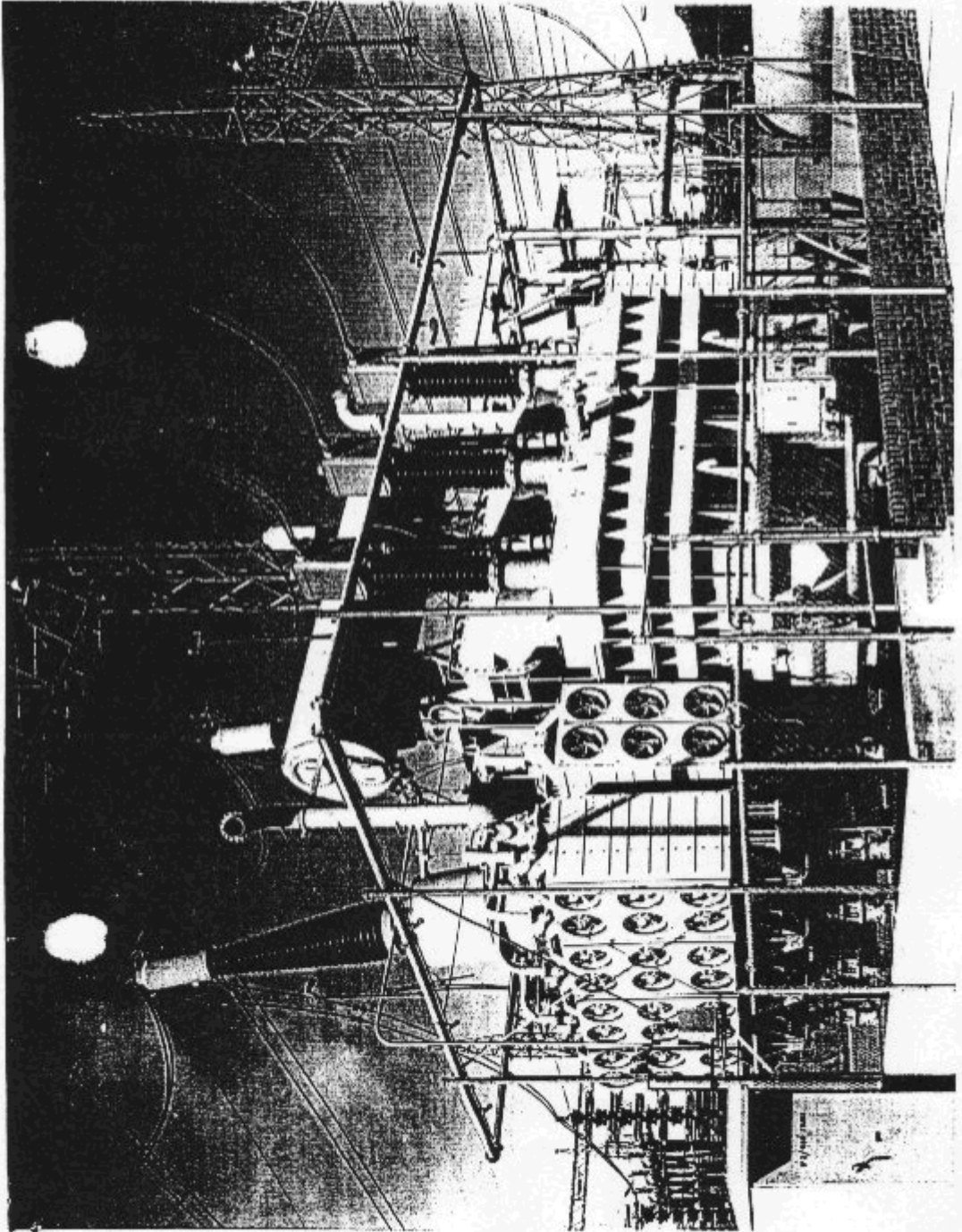

CAPACITOR BANK PROTECTION

High Voltage Capacitor Banks are installed in substations to provide reactive power (Vars) when load on the substation is mostly inductive.

This has the effect of correcting power factor and also maintaining normal system voltage at the substation.

Capacitor banks are groups of individual paper capacitors housed in steel cans, and arranged as three phase star or delta connections.

Most high voltage capacitor banks are connected as double star connected banks as shown in FIG 1.

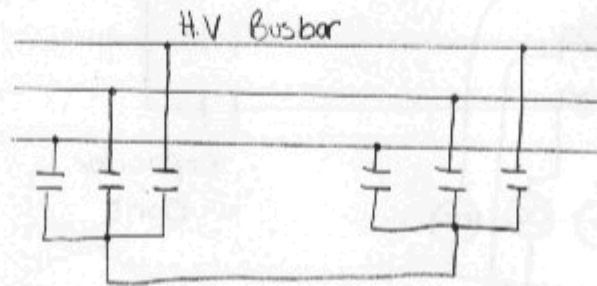

FIG 1

An alternative connection of capacitors is the split phase arrangement where there are two series connected groups in parallel with each other in each of the star connected phases as shown in FIG 2.

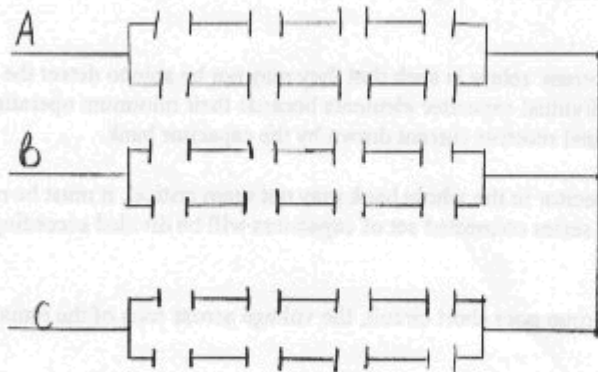

FIG 2

Overcurrent and Earth Leakage Protection of Capacitor Banks

Insulation failure in individual capacitor cans can lead to earth faults in the bank, while short circuiting of a number of cans in a phase can lead to excessive current being drawn.

Overcurrent and earth leakage protection can be applied to a capacitor bank using conventional non-directional induction disc overcurrent relays.

Refer to FIG 3 which shows a two phase overcurrent and earth leakage scheme applied to a capacitor bank.

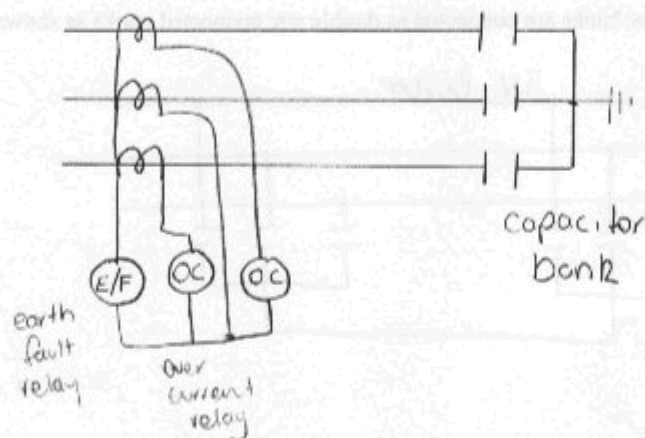

FIG 3

The relays are supplied from current transformers installed on the high voltage lines.

The two overcurrent relays will detect excessive current in the lines caused by phase-phase faults, and the earth fault relay will detect zero sequence components of earth fault current or unbalance current.

The sensitivity of the overcurrent relays is such that they may not be able to detect the failure (open or short circuit) of individual capacitor elements because their minimum operating current must be higher than the normal reactive current drawn by the capacitor bank.

While the failure of one capacitor in the whole bank may not seem critical, it must be remembered that the voltage applied to a series connected set of capacitors will be divided according to their capacitance values.

If one capacitor in a series group goes short circuit, the voltage across each of the remaining capacitors will increase.

This will result in the other capacitors being overstressed and possibly lead to sequential failure of the remaining capacitors.

Capacitor Bank Out of Balance (OOB) Protection

In addition to Overcurrent and Earth Leakage Protection, a sensitive detection scheme must be used to identify the failure of individual capacitor elements in a capacitor bank.

Refer to FIG 4 which shows an OOB relay connected to a double star connected capacitor bank.

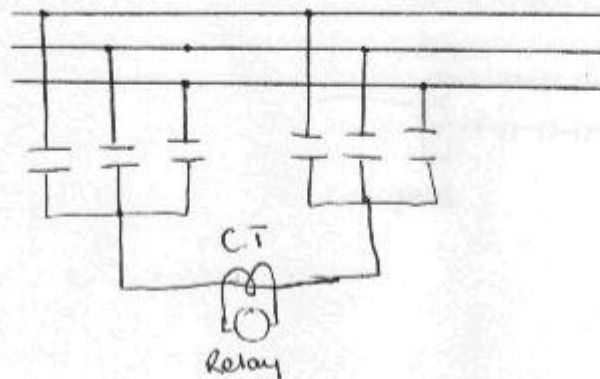

FIG 4

ORIG

The relay is supplied from a current transformer which is installed in the connection between the star points of the two star connected banks.

If the two star connected capacitor banks are healthy and perfectly balanced, the potential difference between the two star points should be zero, and no current will flow through the primary of the CT.

If a capacitor element fails (becomes open or short circuit), the voltage at the star point of that bank will shift from zero, and OOB current will flow between the two star points, producing an output on the CT and causing relay operation.

The relay pickup value can be set very low if required (enough to detect one faulty capacitor) because under normal operation, there is no current between the star points and therefore no relay current.

● Out of Balance Protection Applied to Split Phase Capacitor Banks

The Split Phase Capacitor Bank shown in FIG 2 requires special attention to detect a capacitor failure in either of the two parallel branches in each phase.

Refer to FIG 5 which shows OOB relays connected in each phase of the capacitor bank.

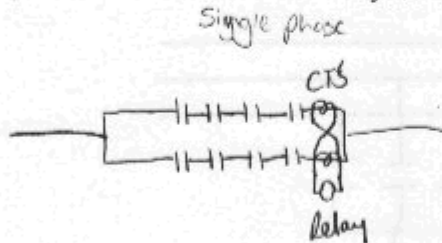

FIG 5

- Notes:**
- Two CTs are connected back-back, one in each parallel branch of the phase connection.
 - The summated output of the two CTs supplies a relay.
 - If all capacitors in the capacitor bank are healthy, the currents flowing in the two parallel branches will be equal and the two CT secondary currents will balance, giving no relay current.
 - If one capacitor element fails, the unequal currents in the parallel branches will produce unequal CT outputs.
 - The unequal CT outputs will produce a relay current, causing relay operation and subsequent tripping of the circuit breaker which controls the capacitor bank.

Balancing of the Capacitor Bank

The extreme sensitivity of the OOB scheme means that the individual branches of the capacitor bank must be correctly balanced during commissioning and also after replacement of individual capacitors after failure.

The percentage tolerance of individual capacitor elements, means that capacitance measurement of each can and calculation of total branch capacitance must be carried out so that perfect balance is obtained in normal service.

If a perfect balance is not possible, then the OOB relays must be de-sensitized so that they ignore the small OOB that exists normally.

Protcap.wpsuvol3

TRANSMISSION LINE PROTECTION

Unit Protection Scheme

A "Unit" Protection scheme is a protective scheme which will respond only to fault conditions occurring within a clearly defined zone.

It is sometimes called "Restricted Zone" Protection.

As the scheme does not involve "time grading", it can be relatively fast in operation (instantaneous).

A "restricted zone" is usually achieved by means of a comparison of quantities at the boundaries of the zone ($\Sigma I_{in} = \Sigma I_{out}$).

Differential Protection

"Differential Protection" is a scheme which compares the sum of the currents entering the zone (ΣI_{in}) with the sum of the currents leaving the zone (ΣI_{out}).

Differential Protection can be applied to Generators, Transformers, Busbars and Transmission Lines.

The scheme requires current transformers (CTs) to be placed on the line to measure current flow at every zone boundary.

The physical position of the CTs determines the boundary of the zone.

Refer to FIG 1 which shows a single phase representation of a simple differential scheme using two CTs.

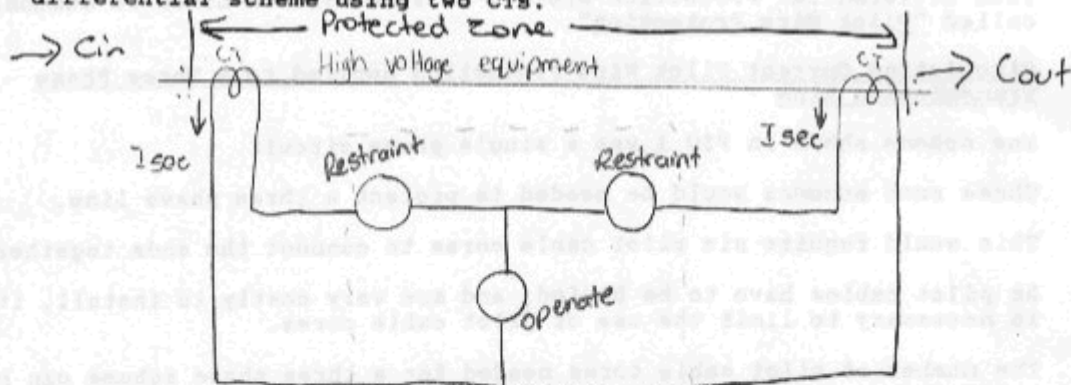

FIG 1

Notes: The limits of the "protected zone" are where the CTs are placed on the line.

The two CTs have equal ratios.

An "internal" fault is defined as a fault occurring within the protected zone.

An "external" fault is defined as a fault occurring outside the protected zone.

This connection is called a "Circulating Current" connection because under no fault or external fault conditions, the outputs from the two CTs are equal, and will "circulate" between the two CTs.

Only out of balance current from the two CTs will flow through the relay operating coil.

There will be much out of balance current from the CTs when a fault occurs within the protected zone because the total current entering the zone will be greater than the total current leaving the zone.

The operation of the relay would have to initiate a trip of the circuit breaker (CB) on each side of the fault to completely clear the fault.

Differential Protection Applied to Transmission Lines

As the two ends of the transmission line will be many kilometres apart, there will be a relay at each end of the line to trip the CB at each end of the line.

So that the outputs of the two CTs at each end of the line can be compared, the two ends of the scheme must be joined together by "Pilot Cables", which are underground multicore cables usually used for communications and/or auxiliary control functions.

Thus Differential Protection applied to Transmission Lines is commonly called "Pilot Wire Protection".

Circulating Current Pilot Wire Protection applied to a Three Phase Transmission Line

The scheme shown in FIG 1 was a single phase circuit.

Three such schemes would be needed to protect a three phase line.

This would require six pilot cable cores to connect the ends together.

As pilot cables have to be buried, and are very costly to install, it is necessary to limit the use of pilot cable cores.

The number of pilot cable cores needed for a three phase scheme can be reduced from six to two by using "Summation" current transformers at each end of the differential scheme.

A "Summation" CT provides a single phase output which is proportional to a three phase input.

Refer to FIG 2 which shows a Circulating Current Pilot Wire Protection Scheme applied to a three phase transmission line.

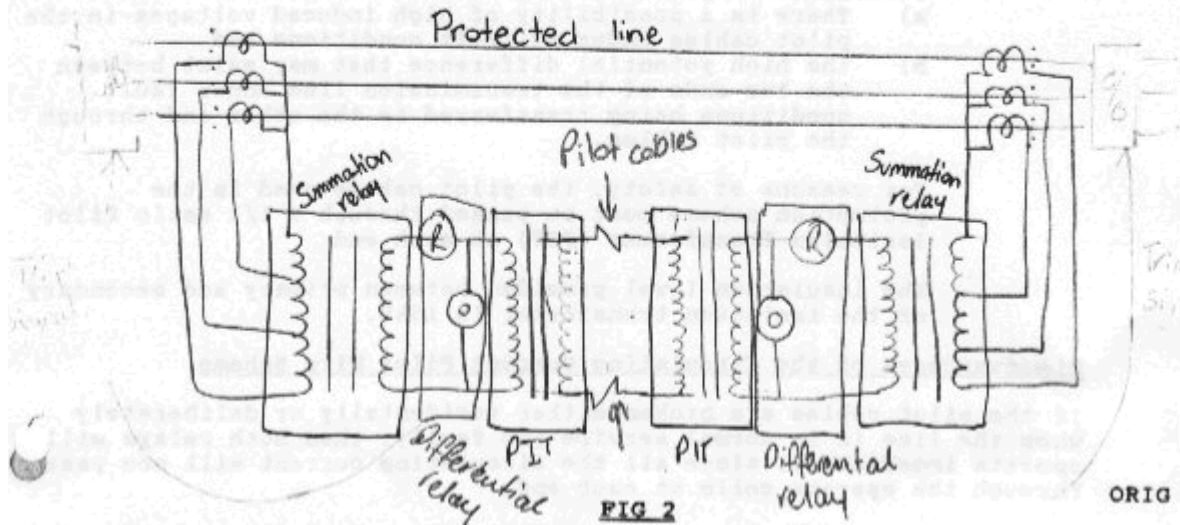

Notes: The outputs from the three CTs at each end are applied to a summation transformer and provide a single phase quantity for comparison with quantity from the other end through two pilot cable cores.

There is a detecting relay at each end of the line.

The detecting relays have both "operating" and "restraining" coils.

When current flows through an "operate" coil, the relay tends to close contacts and operate.

When current flows through a "restraint" coil, the relay contacts are held open and the relay does not operate.

The operate and restraint quantities work against each other, so that when operate is greater than restraint, the relay will operate and vice versa.

The addition of a restraint coil to the relays, provides stability, for situations where there may be some small out of balance current under no fault conditions, due to CT errors or mismatch.

Under no fault or through fault conditions, current circulates from end to end through the restraint coils, and no current flows through the relay operate coils.

When a fault occurs within the protected zone, the large out of balance current will flow through the operate coils of both relays causing relay operation since there will be very little if any restraint coil current.

PR 54

Two hazardous conditions can exist when connecting two substations together with pilot cables.

- a) There is a possibility of high induced voltages in the pilot cables under HV fault conditions and
- b) the high potential difference that may exist between the two ends of the transmission line under fault conditions being transferred to the other end through the pilot cables.

For reasons of safety, the pilot cables used in the protection scheme must be passed through a 1/1 ratio Pilot Isolation Transformer (PIT) at each end.

The insulation level provided between primary and secondary of the isolation transformer is 15kV.

Disadvantages of the Circulating Current Pilot Wire Scheme

If the pilot cables are broken either accidentally or deliberately when the line is in normal service (no fault), then both relays will operate immediately, since all the circulating current will now pass through the operate coils at each end.

If the pilot cables are short circuited, the scheme may be rendered inoperative.

Balanced Voltage Pilot Wire Protection applied to a Three Phase Transmission Line

The Circulating Current Pilot Wire Protection Scheme can be converted to a "Balanced Voltage" scheme by crossing the connections between the two ends that are compared.

Refer to FIG 3 which shows a single phase "Balanced Voltage" differential scheme.

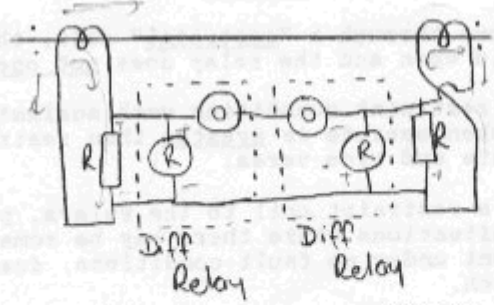

FIG 3

ORIG

Notes: The scheme is similar to the Circulating Current scheme except that polarities are arranged so that no current flows from end to end except under fault conditions.

The positions of the operate and restraint coils are reversed.

All other features of the three phase CC scheme are included (pilots, summation CTs, PITs etc)

Disadvantages of the Balanced Voltage Scheme

Open circuit pilots will render the scheme inoperative.

Short circuit pilots may cause operation of the scheme under no fault conditions, depending on the location of the short in the pilots.

Pilot Wire Supervision Scheme used on Balanced Voltage Pilots

The possibility that the balanced voltage scheme may not operate when required, due to damaged pilots, requires supervision of the continuity of the pilot cable cores used for the scheme.

Two methods can be used to detect damage to pilot cables.

- a) Use the outer pilot cable cores for communication services, and the loss of communication circuits would indicate possible pilot cable damage.
- b) At one end of the scheme, superimpose a DC supply between the two pilot cable cores used for the pilot wire scheme, and connect a supervision relay across the pilots at the other end, to initiate an alarm should the DC supply disappear.

Distance Protection

Distance Protection is a scheme which measures the distance to the point of fault from the measuring point by calculating the impedance along the line (ratio of magnitudes of faulty phase voltage and faulty phase current gives ratio $Z = V/I$).

Examples:

1. Fault a long distance away.

V = high value and I = low value

$$\text{Ratio } Z = \frac{V}{I} = \frac{\text{high}}{\text{low}} = \text{high value}$$

The high value of impedance measured is consistent with the fault at a long distance from the measuring point or no fault at all.

2. Fault a short distance away.

V = low value and I = high value

$$\text{Ratio } Z = \frac{V}{I} = \frac{\text{low}}{\text{high}} = \text{low value}$$

The low value of impedance measured is consistent with the fault close to the measuring point.

This means that the closer the measuring point is to the fault, the lower is the faulty phase voltage and the higher is the faulty phase current and vice versa.

Balanced Beam Comparator

The balanced beam comparator can be used to compare the magnitude of two quantities.

Refer to FIG. 4 which shows the arrangement of a Balanced Beam Comparator.

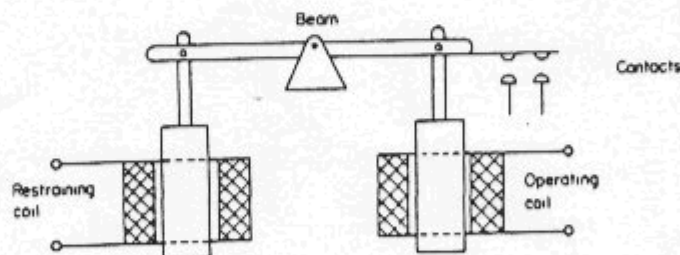

FIG 4

The balanced Beam Comparator has two coils and armatures,

- i) an operate coil which when energised will tilt the beam to close the relay contacts,
- ii) a restraint coil which when energised will tilt the beam to keep the relay contacts open.

When the two coils are energised simultaneously, if the operate quantity is greater than the restraint quantity, then the relay will close contacts and operate.

If the restraint quantity is greater than the operate quantity, then the relay contacts will remain open and the relay restrains.

The Balanced Beam Comparator used as an "Impedance" Relay

The balanced beam comparator can be used as an "impedance" measuring device by connecting it in the following way:

- a) faulty phase voltage connected to the restraint coil,
- b) faulty phase current connected to the operate coil.

There will be a particular ratio of $Z = V/I$ at which the beam will balance (neither operate nor restrain).

If the current is slightly higher and voltage slightly less (fault closer), then the beam will tilt and close contacts (operate).

If the current is slightly lower and voltage slightly higher (fault further away), then the beam will tilt and open contacts (restrain).

These characteristics give the "impedance" relay a circular characteristic as shown in FIG 5.

ARGAND

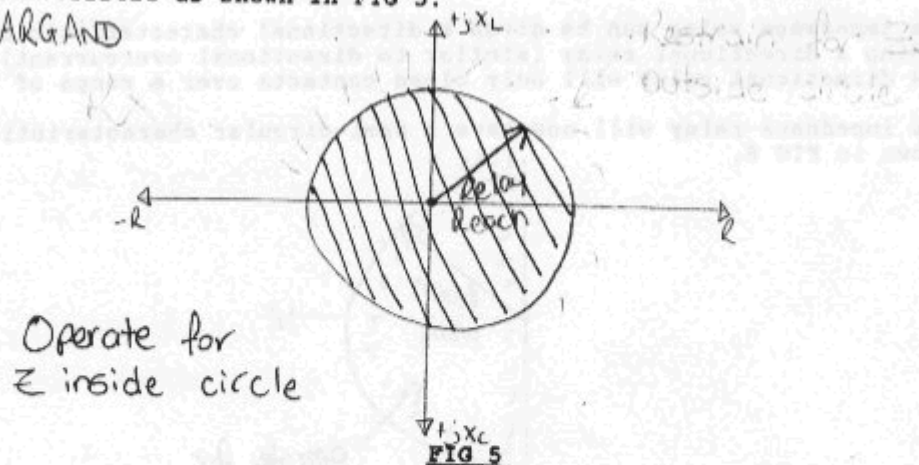

Notes: The circular characteristic is drawn on a set of R/X axes known as an Argand diagram.

PR 5b

Any combination of V and I giving a value of Z inside the circle will cause relay to operate.

Any combination of V and I giving a value of Z outside the circle will cause relay to restrain.

The circumference of the circle is the balance point of the beam (neither operate nor restraint) and is called the "reach" point of the relay.

The radius of the circle is the reach of the relay in ohms along the line from the measuring point.

The reach of the relay can be changed by adjusting the sensitivity of the operate and restraint coils or by changing the ratios of the CT and VT supplying the current and voltage.

The impedance relay has no directional characteristic and only measures the magnitude of fault impedance at any impedance angle..

Impedance measured in the forward direction (out along the line) will be in the range $+jX_L$ through pure R to $-jX_C$.

Impedance measured in the reverse direction (behind the relaying point) will be in the range $+jX_L$ through -R to $-jX_C$.

Impedance measured in the reverse direction corresponds to fault current flowing into the measuring point from the other end of the line.

Directional Impedance Relay

The impedance relay can be given a directional characteristic by adding a directional relay (similar to directional overcurrent) where the directional relay will only close contacts over a range of 180° .

The impedance relay will now have a semi-circular characteristic as shown in FIG 6.

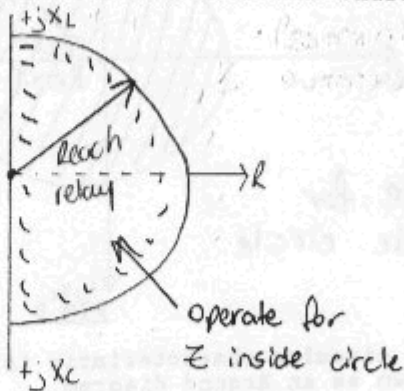

FIG 6

ORIG

While the addition of the directional characteristic has prevented the relay from operating for reverse faults, the relay characteristic is far from ideal for measuring impedance of a transmission line under fault conditions.

Most transmission lines under short circuit conditions, are highly inductive, and have fault impedance angles in the range 60° for 33kV lines to almost 90° for 500kV lines.

Generally, the higher the operating voltage of the transmission line, the higher is the impedance angle.

Ideally, the relay should measure the impedance of the line at the exact line impedance angle.

Polarised Mho Distance Relay

The Mho (Admittance) relay is a modified impedance relay which has a directional characteristic, offsetting the circle from the origin.

The relay can be polarised to look in a particular direction with the circumference passing through the origin of the Argand diagram as shown in FIG 7.

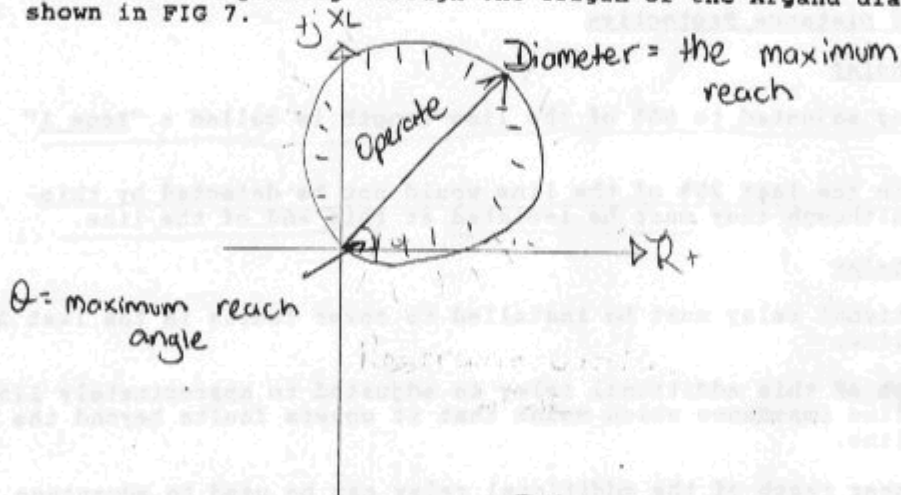

FIG 7

ORIG

Notes: Relay reach is measured from the origin to the circumference of the circle.

The diameter of the circle is the maximum reach of the relay.

The circle is offset and the diameter is inclined at an angle θ° from the zero axis.

θ° is called the "Maximum Reach Angle" (MRA) of the relay.

The MRA of the relay should be the same as the impedance angle of the transmission line.

Setting the Maximum Reach of the Distance Relay

The maximum reach of the relay can be adjusted to look as far along the line as desired, for fault detection.

Ideally, the relay should be adjusted to reach exactly 100% of the length of the line, and as it is a "restricted zone" scheme, it can be made to trip instantaneously.

However, errors in the CTs and VTs supplying the relay, relay inaccuracies and line impedance variation, mean that it is almost impossible to adjust the reach of the relay to exactly 100% of the line length.

For these reasons, the relay is adjusted to reach only 80% of the length of the line so that the relay never over-reaches and trips for a fault beyond the end of the line.

Faults beyond the end of the line should be detected and isolated at the next substation, so that unnecessary tripping does not occur at remote locations.

Zones of Distance Protection

Zone 1 Relay

The relay adjusted to 80% of the line length is called a "Zone 1" relay.

Faults in the last 20% of the line would not be detected by this relay, although they must be isolated at this end of the line.

Zone 2 Relay

An additional relay must be installed to cover faults in the last 20% of the line.

The reach of this additional relay is adjusted to approximately 125% of the line impedance which means that it covers faults beyond the end of the line.

This longer reach of the additional relay can be used to advantage, by providing remote backup to protection at the remote substation, should there be a failure to trip at that location.

This second relay is called a "Zone 2" relay and will operate for faults from 0-125% of the line impedance.

A reach of 125% of line impedance will extend into the equipment at the next substation, and depending on how the transmission line is terminated (either directly into a transformer or onto a busbar), the Zone 2 relay may detect faults in the transformer windings or out along another line connected to the remote busbar.

Therefore the Zone 2 relay is time delayed by about 30 to 50 cycles (0.6-1.0sec) to provide time grading with the remote protection scheme that it is backing up.

Zone 3 Relay

One disadvantage of the Polarised Mho Zone 1 relay characteristic, is that the relay will not operate for a "zero ohms" fault (three phase short circuit at the measuring point due to operator accidentally closing CB onto a set of earths).

This close in three phase fault is very severe, and will not be detected by the Polarised Mho relay because it lies on the circumference of the circle (a non-operate condition).

To cover this contingency, a third relay is installed at the measuring point which has the circumference offset from the origin, so that "zero ohms" lies within the operate region of the relay.

This relay is called an "Offset Mho" relay, and its characteristic is shown in FIG 8.

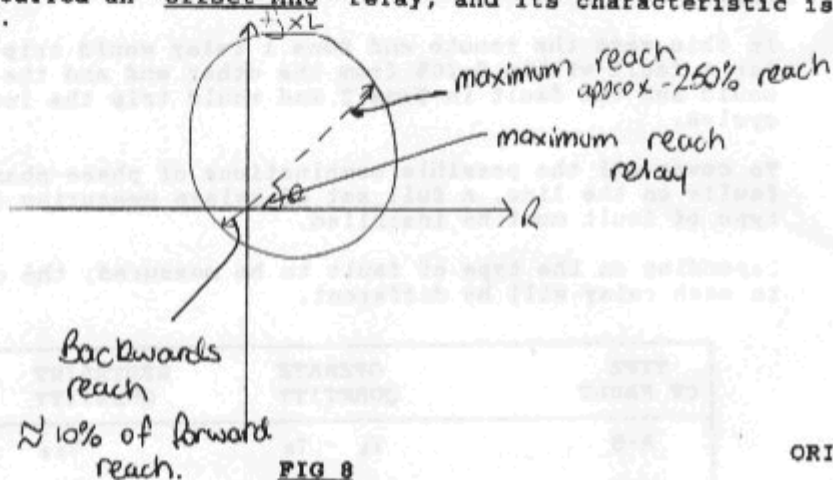

FIG 8

ORIG

Notes: The circle diameter is inclined like the polarised mho relay at angle θ called the Maximum Reach Angle. The relay has a forward reach and also a backward reach which is approximately 10% of the forward reach value. The forward reach of the relay is adjusted to approximately 250% of the line impedance.

The additional reach of the "Zone 3" relay is intended to provide additional remote backup beyond Zone 2.

The Zone 3 relay has a time delay on tripping of about 150 cycles (3sec) to allow remote protection to more correctly operate and clear faults at remote locations.

Three Phase Three Zone Distance Protection Scheme

The use of three relays (Zones 1, 2 and 3) provides instantaneous tripping for faults in the first 80% of the line, 30 cycle delayed tripping for the last 20% of the line, and delayed remote backup for distant faults.

The delayed tripping for faults in the last 20% of the line may seem undesirable, except that depending on the system fault impedance, the end of line fault will be less severe.

This would be the case for a radial feeder, but in the case of an interconnector (power source at both ends), the fault would be fed from both ends and would require a CB at each end of the line, and sets of distance relays installed at each end looking towards each other.

In this case the remote end Zone 1 relay would trip the remote end CB for a fault within 0-20% from the other end and the local end relay would see the fault in Zone 2 and would trip the local CB in 30 cycles.

To cover all the possible combinations of phase-phase and phase-earth faults on the line, a full set of relays measuring impedance for each type of fault must be installed.

Depending on the type of fault to be measured, the quantities applied to each relay will be different.

| TYPE OF FAULT | OPERATE QUANTITY | RESTRAINT QUANTITY | POLARISING QUANTITY |
|---------------|------------------|--------------------|---------------------|
| A-B | $I_A - I_B$ | V_{AB} | V_{CA} |
| B-C | $I_B - I_C$ | V_{BC} | V_{AB} |
| C-A | $I_C - I_A$ | V_{CA} | V_{BC} |
| A-E | $I_A - kI_W$ | V_{AW} | V_{CW} |
| B-E | $I_B - kI_W$ | V_{BW} | V_{AW} |
| C-E | $I_C - kI_W$ | V_{CW} | V_{BW} |

Notes: The operate quantity is derived from the faulty phase current.

The restraint quantity is derived from the faulty phase voltage.

The polarising quantity specified is required to give the relays the polarised characteristic, and is derived from the "leading healthy phase voltage" in each case.

During a close in three phase zero volt fault, all the restraint and polarising voltages are zero, and this results in the polarised mho relay remaining inoperative.

Correct earth fault measurement requires a compensation factor to be applied to allow for earth return path impedance, and so a proportion of earth current (kI_E) is used.

Overall Characteristics of the Three Zone Distance Scheme

Combining the characteristics of the Zone 1, 2 and 3 relays on the one diagram gives the overall characteristics shown in FIG 9.

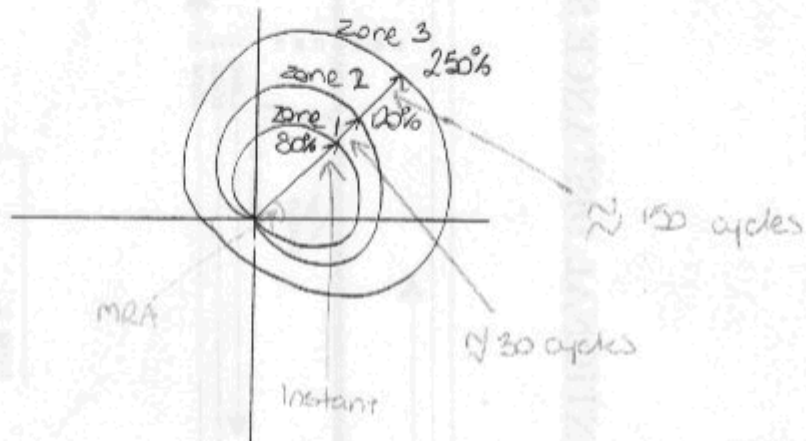
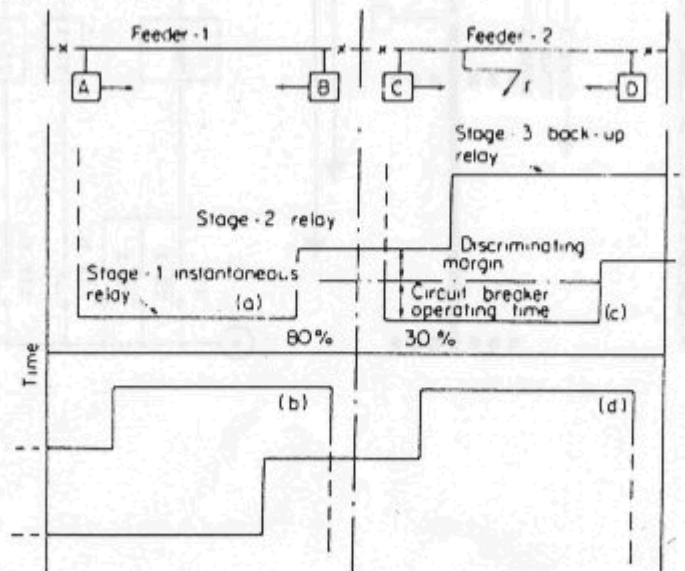

FIG 9

ORIG

The time/distance relationships for the three zone scheme is represented by FIG 10.



ORIG

prgm

FIGURE NO. 14 CONVENTIONAL DISTANCE SCHEME

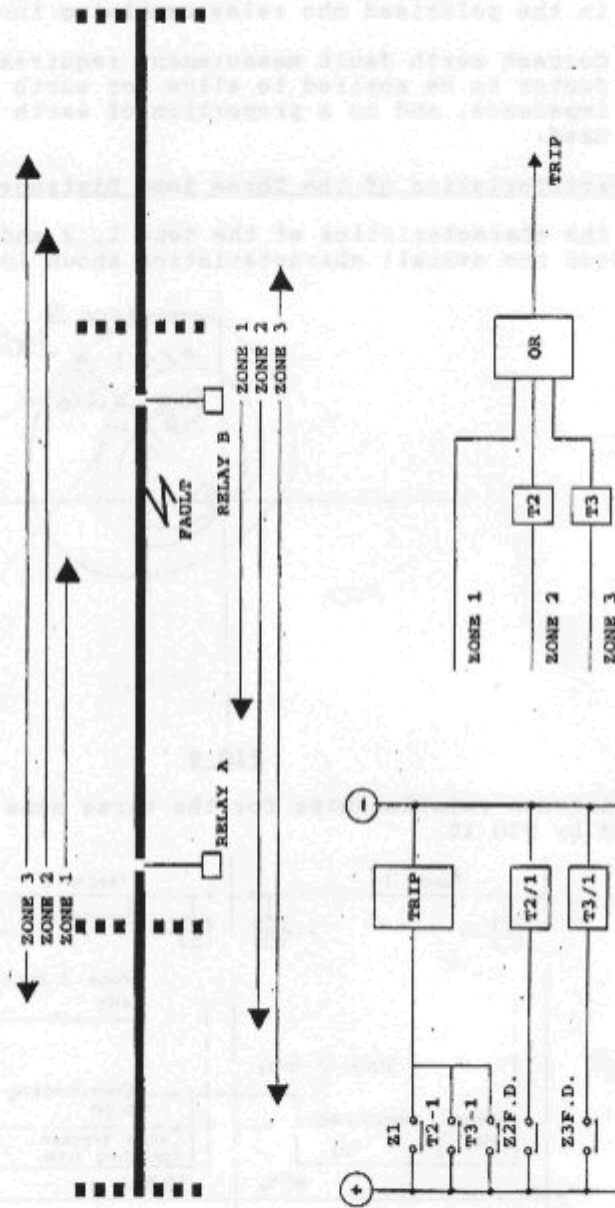

785

PR65

S 3/78/2003/1

10

PROTECTIVE TRANSFORMERS

| | <u>Page No.</u> |
|--|-----------------|
| 1. <u>GENERAL</u> | 2 |
| 1.1 Introduction | 2 |
| 1.2 Basic Transformer Principles | 2 |
| 2. <u>STEADY-STATE THEORY OF CURRENT TRANSFORMERS</u> | 84 |
| 2.1 Equivalent Circuit, Vector Diagram, Errors | 84 |
| 2.2 The Influence of the Core, Magnetic Materials and Magnetisation Curves | 86 |
| 2.3 Single-Term Primary Current Transformers | 89 |
| 2.4 Flux Leakage | 89 |
| 2.5 Balancing Windings and Eddy-Current Shielding | 711 |
| 2.6 Open-Circuit Secondary Voltage | 813 |
| 2.7 Secondary Currents, Burdens and Connecting Lead Resistance | 814 |
| 3. <u>CONSTRUCTION OF CURRENT TRANSFORMERS</u> | 814 |
| 3.1 Basic Types | 814 |
| 3.2 Oil-Filled Outdoor Single Phase C.T.'s | 1816 |
| 4. <u>CLASSIFICATION OF C.T. S</u> | 1818 |
| 4.1 Terminal Marking | 1818 |
| 4.2 Protection Current Transformers | 1819 |
| 4.3 Special Purpose Protection Current Transformers | 1819 |
| 4.4 C.T. Ratios | 1820 |
| 4.5 Classification of Multi-tapped C.T. s | 1820 |
| 5. <u>INTERPOSING AND SUMMATION C.T. S</u> | 1822 |
| 6. <u>TESTING OF PROTECTION C.T. S</u> | 1822 |
| 6.1 Magnetisation Test | 1822 |
| 6.2 A.C. Ratio Check | 1829 |
| 6.3 D.C. Polarity Check | 1829 |
| 6.4 A.C. Ratio and Polarity Check on a Three Phase Set Of C.T.'s | 1829 |

Q11

1. GENERAL

PR 66

1.1 Introduction

C.T.'s and V.T.'s are necessary to isolate the voltage and current coils of the relays from the high voltages of the power system, and to supply standard values of current and voltage to the relays, for example 5A or 1A for current coils and 110V for voltage coils, thus enabling standard relays to be 'matched' to any power system.

1.2 Basic Transformer Principles

When an alternating current flows in the primary winding, that current creates a magneto-motive force (m.m.f.) which results in an alternating flux in the core, which, in turn, induces an electromotive force (e.m.f.) in the primary winding and in any other windings wound on, or linked with, the core.

A transformer, consisting of a core of magnetic material on which are wound two windings, can be operated in two basic modes, shunt and series.

In the shunt mode, as in power or voltage operation, a voltage is applied to the terminals of the primary windings, which, since the induced e.m.f. in the primary winding is sensibly equal to this applied voltage, determines the magnitude of the core flux and, therefore, for a given sectional area of core, the flux density in the core. With no burden (load) connected to the secondary terminals the current flowing in the primary winding will be that necessary to excite the core. With a burden connected to the secondary terminals current will flow in the secondary winding, its value depending on the impedance of the burden, and additional current will flow in the primary winding depending on the turns-ratio of the transformer. The ampere-turns (AT) of the primary winding always exceed those of the secondary winding by the amount necessary to excite the core.

In the series mode, that is, in current operation, the primary winding is connected in series with the power system whose relatively high impedance determines the magnitude of the primary current, and a component of this current excites the core to the flux density necessary to induce in the secondary winding an e.m.f. sufficient to drive the secondary current through the total impedance of the secondary circuit.

In power and voltage transformers, therefore, the core flux density is substantially constant under normal operating conditions; but in current transformers it is dependent on the magnitude of the primary current and the impedance of the secondary circuit.

Figure 1 shows a simplified equivalent circuit for a two-winding transformer of 1/1 turns ratio, the leakage inductances having been omitted. (See section 2.4). In voltage operation we are interested in the magnitude and phase differences between the primary and secondary voltages V_p and V_s , caused by the currents I_p and I_s flowing in the primary and secondary windings, the resistances of which are denoted by R_p and R_s respectively.

3/78/2003/38

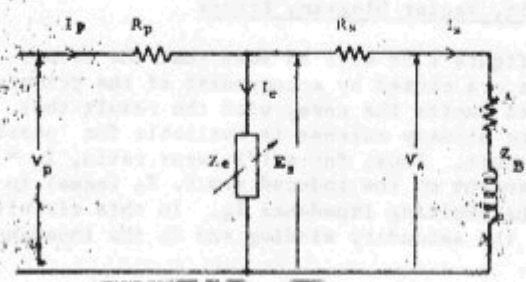

Figure 1 Equivalent Circuit for a Transformer of 1/1 Turns Ratio and Negligible Leakage Flux

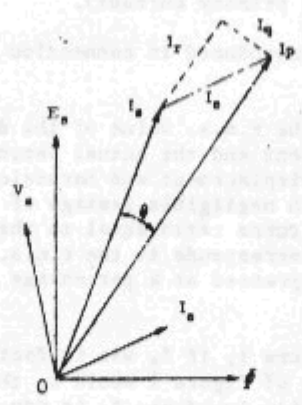

Figure 2 Vector Diagram for Circuit of Fig.3.1

In current operation, however, we are not usually interested in these voltage relationships at all but in the relationship between the primary current I_p and the secondary I_s . It will be noted that these currents differ by the amount of the core exciting current I_e which is, of course, a component of I_p .

2. STEADY-STATE THEORY OF CURRENT TRANSFORMERS

2.1 Equivalent Circuit, Vector Diagram, Errors

Referring to figure 1 it will be seen that the errors of a current transformer are caused by a component of the primary current being utilised to excite the core, with the result that only the remainder of the primary current is available for 'passing on' to the secondary circuit. Thus, for a 1/1 turns ratio, $I_s = I_p - I_e$ where I_e is dependent on the induced e.m.f. E_s (equal to $I_s (R_s + Z_B)$), and on the exciting impedance Z_e . In this circuit R_s is the resistance of the secondary winding and Z_B the impedance of the secondary burden.

Treating Z_e as a linear impedance, the vectorial relationship between the fundamental frequency currents are typically as in figure 2. This shows that the vector difference between I_p and I_s is I_e , and that I_r , the component of I_e in phase with I_p , constitutes the current (magnitude) error and I_q , the component of I_e in quadrature with I_p , results in the phase error θ . The relative values of the current error component I_r and the phase error component I_q depend on the phase displacement of I_s and I_e , the current error being a maximum and the phase error zero when I_s and I_e are in phase, that is when the total impedance of the secondary circuit and the exciting impedance Z_e are of like power factor. Under such conditions the current error of a transformer with no turns correction, that is, with its turns ratio equal to the nominal current ratio, is equal to the fundamental frequency component of the exciting current (usually expressed as a percentage of the primary current).

Composite Error - This term is introduced in connection with protective current transformers.

'Composite Error' is the r.m.s. value of the difference between the ideal secondary current and the actual secondary current, including the effects of phase displacement and harmonics of the exciting current. In a c.t. with negligible leakage of flux and no turns correction, that is, with turns ratio equal to the nominal current ratio, composite error corresponds to the r.m.s. value of the exciting current (usually expressed as a percentage of the primary current).

Again referring to figure 1, if Z_e was in fact a linear impedance the vectorial error I_e of figure 2 would be the composite error. In practice the magnetising impedance Z_e is non-linear, with the result that the exciting current I_e contains some harmonics of the fundamental frequency which increase its r.m.s. value and thus increase the composite error. This effect is most noticeable in the region approaching saturation of the core.

S 3/78/2003/28

PR69

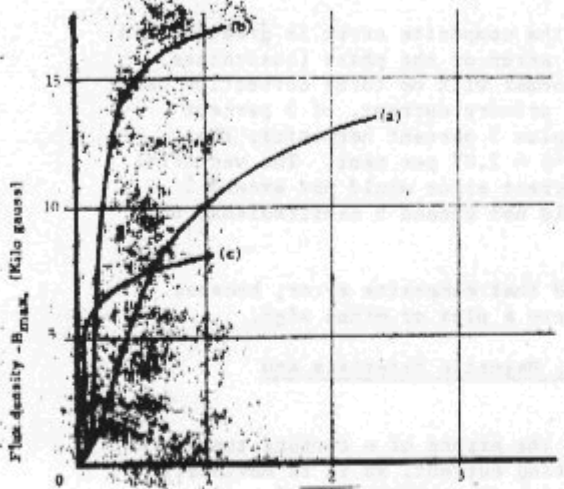

Figure 3
50Hz Magnetisation Curves
(a) Cold-rolled non-oriented silicon steel;
(b) Cold-rolled oriented silicon steel;
(c) Nickel-iron (80 percent nickel).

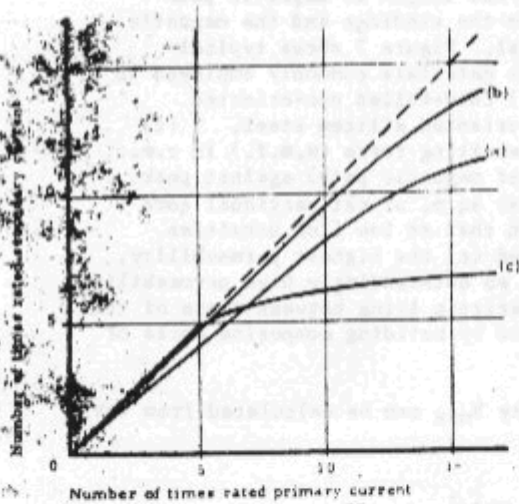

Figure 4
Typical Performance Curves with the Magnetic Materials of figure 3.3

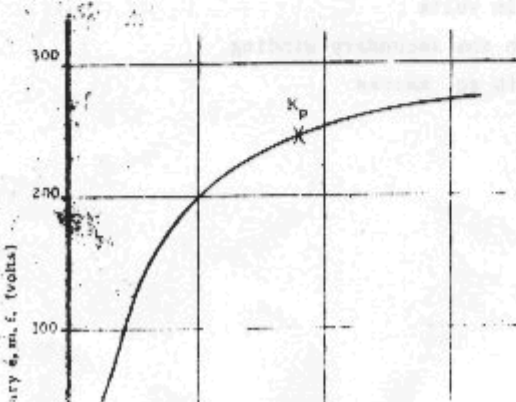

Figure 5
Magnetising Curves for a C.T. Turns Ratio 500/1 Secondary Resistance 22

It will be noted that the composite error is greater than the vectorial error, the current error or the phase (quadrature) error. For example, if a transformer with no turns correction had an exciting current, in terms of primary current, of 5 percent fundamental frequency component plus 5 percent harmonics, the composite error would be $(5^2 + 5^2) = 7.07$ per cent. The vectorial error would be 5 percent, the current error would not exceed 5 percent, and the phase error would not exceed 5 centiradians, that is, 2.87 degrees.

It should also be noted that composite error, because it includes harmonics, cannot carry a plus or minus sign.

2.2 The Influence of the Core, Magnetic Materials and Magnetisation Curves

It has been shown that the errors of a current transformer (c.t.) result from the core exciting current, so it is obviously of first importance when considering the performance of a c.t. to be able to calculate or measure the exciting current.

The excitation or magnetisation characteristics of a c.t. depend on the cross-sectional area and length of magnetic path of the core, the number of turns in the windings and the magnetic characteristics of the core material. Figure 3 shows typical magnetisation curves for three core materials commonly employed in instrument transformers, namely (a) cold-rolled non-oriented silicon steel, (b) cold-rolled oriented silicon steel, (c) nickel-iron. The curves show the exciting force (m.m.f.) in r.m.s. AT/cm (ampere-turns per cm length of magnetic path) against peak flux density B_{max} in deci-Webers per sq.m. of net sectional core area. It will be seen that at low flux densities (a) has the lowest permeability and (c) the highest permeability, while (b) comes in between but has an outstandingly high permeability at high flux densities. A characteristic lying between those of the individual materials can be obtained by building composite cores of two or more materials.

The core peak flux density B_{max} can be calculated from the formula:

$$B_{max} = \frac{E_s}{4.44 T_s A f} \text{ Wb/m}^2$$

where E_s = the secondary e.m.f. in volts

T_s = the number of turns in the secondary winding

A = the net core section in sq. metres

and f is the frequency.

Reference to figure 1 shows that $E_s = I_s(R_s + Z_b)$, where Z_b is the impedance of the external secondary circuit or the burden, so that for a constant burden Z_b the core flux density varies directly as the secondary current. It will thus be apparent from figure 3 that as the primary, and therefore the secondary, currents are increased, a point is reached at which the core material starts to saturate and the exciting current becomes excessive, thus resulting in excessive current error. The exciting current is, of course, equal to the m.m.f. in AT/cm multiplied by the length of the core path (in cm) and divided by the number of turns in the winding to which it is referred, either primary or secondary.

Reference to figure 3 shows that if the flux density at rated secondary current is 1 deci-Weber/m², a c.t. with a nickel-iron core to curve (c) would have good accuracy up to five times the rated current. If however, cold-rolled silicon steel with characteristics to curve (b) is used, the accuracy would be reasonably good up to 10 or 15 times the rated current although not as good below five times rated current as it would be with core material to curve (c).

Figure 4 shows typical curves relating primary to secondary current using the materials whose magnetisation characteristics are given in figure 3.

When considering the performance to be expected from a given c.t., the exciting current can be measured at various values of e.m.f. For this it is usually more convenient to apply a varying voltage to the secondary winding, the primary winding being open-circuited. Figure 5 shows a typical relationship between secondary e.m.f. and exciting current determined in this manner.

The point K_p on the curve is arbitrarily called the knee-point, and is defined as the point at which an increase of 10 percent in the exciting e.m.f. produces an increase of 50 percent in the exciting current.

From the information given in figure 5 the percentage exciting current, which is equal to the maximum composite error in a c.t. with no turns correction and negligible leakage flux, can be calculated for any operating condition.

For example, with a burden impedance of 15Ω (15VA at 1A) of 0.7 power factor, the total secondary circuit impedance, adding the 2Ω winding resistance vectorially, would be approximately 16.5Ω and the secondary e.m.f. at 1A (500A primary current) would be 16.5V. At 10 times this current E_s would be 165V (assuming no saturation) and the exciting current approximately 70mA, which is 0.7 percent of the ideal secondary current of 10A. This means that the current and composite errors would not exceed 0.7 percent and the phase error could not exceed 0.7 centiradians, equal to $0.7 \times 34.38 = 24$ minutes. (Note: If the burden power factor were 0.7 lagging, the phase error would be unlikely to exceed 10 minutes because the exciting and secondary currents would be almost in phase. See figure 2.

S 3/78/2003/37

PR 71

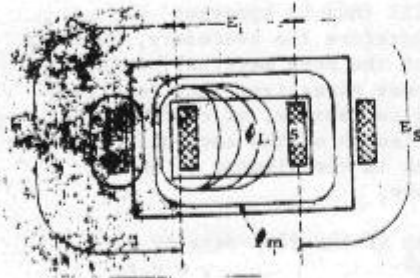

Figure 6
Flux Leakage in Wound-
Primary Current Transformer

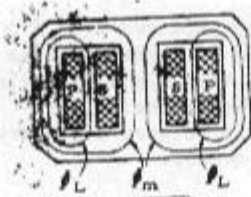

Figure 7
Flux Leakage in Wound-
Primary Current Transformer

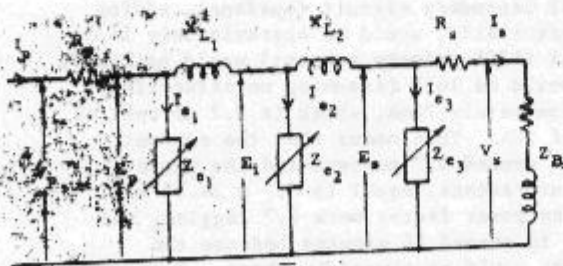

Figure 8
Equivalent Circuit
Including Flux
Leakage Effects

At 7500A primary current the secondary e.m.f. would be approximately 250V, giving an exciting current of 200mA which is 1.33 percent of the nominal secondary current of 15A.

2.3 Single-Turn Primary Current Transformers

Toroidally wound ring core c.t. s are commonly used because they can conveniently be mounted on a bushing in switchgear or a power transformer, which then serves as an insulated single-turn primary. At low primary currents, however, it may be difficult to obtain sufficient output VA at the desired accuracy because, not only is a large core section required to induce the required secondary e.m.f. in the small number of secondary turns associated with the single-turn primary, but also the exciting AT, and, therefore, the errors, are large as a percentage of the small value of primary AT available. In particular, this effect is pronounced when the core diameter is made large in order to fit over a large diameter high voltage bushing, because this increases the length of the flux path and hence the AT necessary to excite the core.

2.4 Flux Leakage

In the foregoing, flux leakage effects have been assumed to be negligible, which fortunately is substantially true for a ring core with uniformly wound secondary winding and centrally positioned primary conductor which does not bend round the outside of the core at a small radius. In wound primary c.t. s particularly when the primary and secondary windings are not closely coupled, there may be considerable leakage flux adding to the mutual flux in the parts of the core where the influence of the m.m.f. due to the primary AT predominates over that due to the opposing AT of the secondary winding, so that the core flux density is non-uniform along the core flux path. An extreme example of this effect, chosen merely for illustration, is shown in figure 1, where the primary and secondary windings are positioned on two opposite limbs of a rectangular core. It will be seen that leakage flux Φ_L adds to the mutual flux Φ_M in the left-hand portion of the core on which the primary coil is wound. Even in designs with concentric primary and secondary windings, such as the shell-type core illustrated in figure 7, the leakage flux passing between the primary and secondary windings and returning to increase the flux density in the outer limbs and yokes of the core is appreciable.

Under conditions such as these, the performance can not be calculated without a detailed knowledge of the flux distribution throughout the core, since, in order to arrive at the total exciting current which constitutes the error in current transformation, it is necessary to assess the sum of the exciting AT required for the various values of flux density existing along the core flux path. Figure 6 shows a simplified equivalent circuit which takes such flux leakage into account. In theory the core flux path would have to be divided into an infinite number of small lengths and the flux density and exciting AT calculated for the flux density of each length. In figure 8, however, the core is considered in three zones having flux densities corresponding to induced e.m.f. s, E_p , E_i (intermediate) and E_s for the three zones indicated in figure 6. These zones have exciting impedances Z_{e1} , Z_{e2} and Z_{e3} taking exciting currents I_{e1} , I_{e2} and I_{e3} respectively.

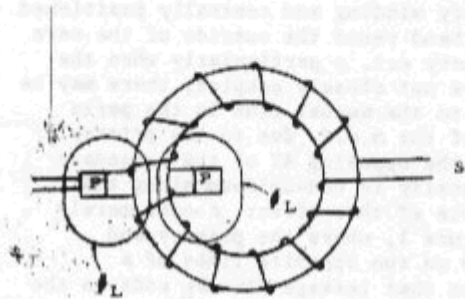

Figure 9 Flux Leakage in a Ring Core with a Concentrated Primary Winding

The effects can be reduced by increasing the core section in the parts of the core carrying the leakage flux, and in shell-type cores such as that shown in figure 7 it is beneficial to increase the section of the outer limbs or yokes to obtain a flux density comparable with that in the centre limb of the core.

This subject is very involved and cannot be treated adequately here, but it might be noted that the concept of representing flux leakage by so-called "secondary reactance", which is considered to add to the burden and therefore to increase the flux density throughout the core, is completely erroneous, and cannot be applied satisfactorily for core flux densities outside the linear portion of the magnetisation characteristic, that is at low and high flux densities.

While, in general, leakage flux should be avoided in protective c.t.'s it can be beneficial in c.t.'s for the operation of meters, instruments and certain forms of protection for the following reasons:

In a c.t. supplying a resistive burden the additional core exciting current due to the leakage flux leads the exciting current due to the mutual flux by 90 degrees. Thus the total exciting current is brought more nearly into phase with the primary current, and this reduces the phase error, while the reduction in secondary current magnitude, due to the same effect, can be compensated by an increase in turns correction, that is a reduction in the number of secondary turns.

Secondly, an increase in leakage flux is accompanied by a decrease in the mutual air flux, so that at primary currents above the value at which the core saturates the increase in secondary current, for a given increase in primary current, is reduced. Thus in c.t.'s with high leakage flux the secondary current is more effectively limited at high system fault currents and this affords protection to the windings and movements of instruments, meters and relays.

2.5 Balancing Windings and Eddy-Current Shielding

It has been shown in the previous section that when leakage flux links the primary winding and not the secondary winding the resultant increase in exciting current results in a reduction of secondary current, that is in a negative current error. When part of the secondary winding is much more closely coupled with the primary winding than the remainder of the secondary winding, so that some core flux links both the primary winding and the more closely coupled part but not the loosely coupled part of the secondary winding, a counter effect occurs which tends to increase the secondary current above the nominal value. This is shown in figure 9 where a ring core with a uniformly spaced secondary winding is linked with an unsymmetrically disposed primary winding, Φ_L being the leakage flux.

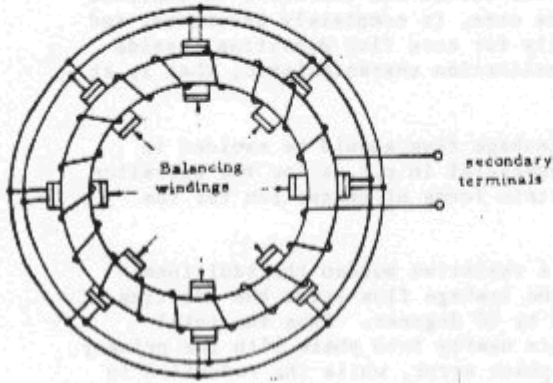

Figure 10
Parallel Connection
of Balancing Windings

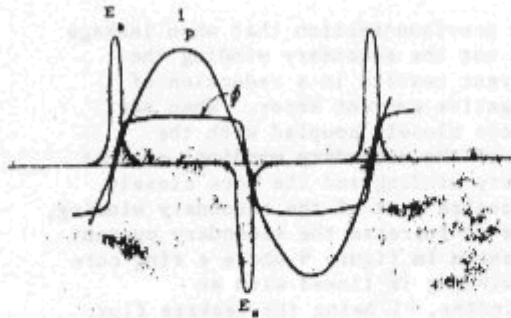

Figure 11
Wave-Shapes of Primary
Current I_p , Core Flux ϕ
and Induced e.m.f. E_g
with Open-Circuited
Secondary Winding

Severe leakage flux effects, whether resulting in positive or negative current errors, are undesirable in c.t. s required for certain forms of balanced protection. In wound primary transformers these effects are under the control of the c.t. designer and can be minimised by suitable disposition of the windings. Also, in the majority of applications where ring core c.t. s with uniformly spaced secondary windings are mounted on bushings, the spacing of the neighbouring phase conductor, which forms the return loop of the primary winding, is such that up to the values of fault current envisaged the leakage flux effects are of little or no consequence. However, there are certain applications where the fault current may be extremely high and the effect of the proximity of the return conductors is not readily assessable by the c.t. designer, and in such instances it may be necessary to employ balancing windings or eddy-current shielding to reduce the leakage flux to an acceptable level.

The arrangement of balancing windings is shown diagrammatically in figure 10. This consists of a number of uniformly disposed windings connected in parallel and having identical turns. The illustration shows the balancing windings wound over the secondary winding but it may be convenient to locate the balancing windings next to the core.

The action of balancing windings is as follows. With uniform flux throughout the core, that is, no flux leakage, equal e.m.f. s are induced in all the windings and because the windings are in parallel no current flows in them. When flux leakage occurs the flux is no longer uniform throughout the core and unequal e.m.f. s are therefore induced in these windings, resulting in circulating currents and local m.m.f. s which counteract the unbalanced m.m.f. s responsible for the flux leakage, thus reducing it.

The secondary winding itself may be arranged to perform the balancing function by forming it from a number of parallel connected coils but, since this would require each coil to have a large number of turns of fine wire, it is usually preferable to employ separate balancing windings each of a few turns of a conductor of comparatively large section. The number of turns in the balancing windings is unimportant, the lower limit being a single-turn for each, connected in parallel by heavy copper rings. It is an obvious step from such an arrangement to enclose the core in a split tubular sheath of conducting material; the gap at the split prevents it forming a short-circuited turn on the core. In effect this is an infinite number of single-turn coils connected in parallel and is more correctly termed an eddy-current shield.

2.6 Open-Circuit Secondary Voltage

It is shown in Section 2.2 that the e.m.f. induced in the secondary winding is that required to drive the secondary current through the total impedance of the secondary circuit, and that the core flux inducing this e.m.f. is provided by a small difference between the primary and secondary AT. With the secondary circuit open, however, there are no secondary AT to oppose those due to the primary current and the whole of the primary AT act on the core as an excessive exciting force, which might drive the core into saturation on each half-wave of current. Typical flux and induced e.m.f. wave shapes for this condition are shown in figure 11 and it will be seen that the high rate of change of the flux Φ in the region of the primary current zero induces an e.m.f., E_s , of high peak value in the secondary winding.

AT - Ampere turns

With rated current in the primary winding this peak value may be as low as a few hundred volts in a small measuring c.t. with a 5A secondary winding, but it might reach many kilo-volts in the case of, say a 2000/1A protective c.t. with a large core section. With system fault currents flowing through the primary winding even higher voltages would be induced. Such voltages not only constitute a hazard to the insulation of the c.t. itself and to connected instruments, relays and associated wiring, but also to life. It is thus important to prevent this condition arising and if the secondary circuit has to be broken for any reason, it is essential first to short-circuit the secondary terminals of the c.t. with a conductor securely connected and capable of carrying the c.t. secondary current.

2.7 Secondary Currents, Burdens and Connecting Lead Resistance

A standard rated secondary current of 5A has been in use for many years. In applications for which the resistance of the leads between the c.t. and the instruments or relays results in an excessive VA burden, rated secondary currents of 2A or even 1A have to be used. For example, if a c.t. is required to supply relays taking 10VA through a loop lead resistance of 0.1Ω the total burden at 5A is $10 + 5^2 \times 0.1 = 12.5\text{VA}$, and a c.t. with a standard output rating of 15VA would be satisfactory. If, however, the lead resistance, due to the distance between the c.t. and relays, is 2Ω , the output required at 5A would be $10 + 5^2 \times 2 = 60\text{VA}$ which would require an excessively large and expensive transformer. By using 1A rated secondary current the output required would be reduced to $10 + 1^2 \times 2 = 12\text{VA}$ which could be provided by a c.t. of reasonable dimensions and cost.

These lower rated secondary currents, however, should not be used indiscriminately because they require an increased number of secondary turns with some increase in dimensions and cost. Further, their use, particularly with c.t. s of high rated primary currents results in increased transient and secondary open circuit voltages. Fortunately, at the higher primary currents, say in excess of 1000A, comparatively high VA outputs are readily obtained, even with single-turn primary c.t. s and an intermediate value of rated secondary current such as 2A may be used.

Auxiliary c.t.'s are sometimes used to reduce the current in high resistance leads but the auxiliary c.t. itself imposes an additional burden of several VA on the main c.t. and tends to offset the reduction in burden caused by the reduced current in the leads.

3. CONSTRUCTION OF CURRENT TRANSFORMERS

3.1 Basic Types

Current transformers can be divided into two major types, the single-turn (bar) primary and the multi-turn wound primary.

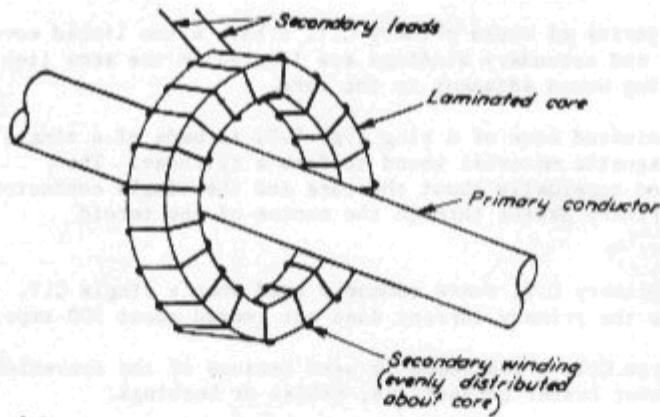

Figure 12 Schematic Drawing of Toroidal Type C.T.

In the former the primary conductor may form part of the C.T. assembly, in which case it must be suitably insulated to withstand the system voltage to earth where it passes through the C.T. core and secondary windings.

The majority of single-turn primary C.T. s make use of an insulated conductor provided as part of other equipment such as bushings of switchgear or power transformers, and the C.T. is merely a ring core with a toroidally wound secondary winding.

Wound primary C.T. s may have the primary and secondary windings arranged concentrically, the secondary winding invariably being the inner winding since it is advantageous to keep the resistance of this winding as low as possible, or, in designs intended primarily for operating instruments, meters and simple overcurrent relays, the primary and secondary windings may be disposed on different limbs of the core. Such an arrangement results in minimum weights of windings, while the flux leakage effect resulting from this loose coupling reduces the phase error and limits the secondary current produced by high primary overcurrents.

The majority of wound primary C.T. s have a two limbed core; both the primary and secondary windings are located on the same limb, the secondary being wound adjacent to the core.

The laminated core of a ring type C.T. is made of a single strip of ferro-magnetic material wound to form a cylinder. The secondary is wound toroidally about the core and the single conductor comprising the primary passes through the centre of the toroid (figure 12).

Wound primary C.T. s are commonly used when a single C.T. is required where the primary current does not exceed about 500 amps.

Ring type C.T. s are commonly used because of the convenience in fitting them over busbar connections, cables or bushings.

The development of low oil content and air blast circuit breakers, which have no bushings over which C.T. s can be mounted, has greatly increased the use of separate single phase post-type C.T. assemblies.

3.2 Oil-Filled Outdoor Single Phase C.T. s

The H.V. winding consists of a hair-pin shaped conductor, usually insulated with oil impregnated crepe paper with metal foils interposed at suitable intervals. The outermost foil is normally connected to earth via an insulated terminal and link for periodic testing of the major insulation.

Suitably mounted in the U-shaped section of the H.V. conductor are the C.T. secondary windings and cores.

8 3/78/2003/1*

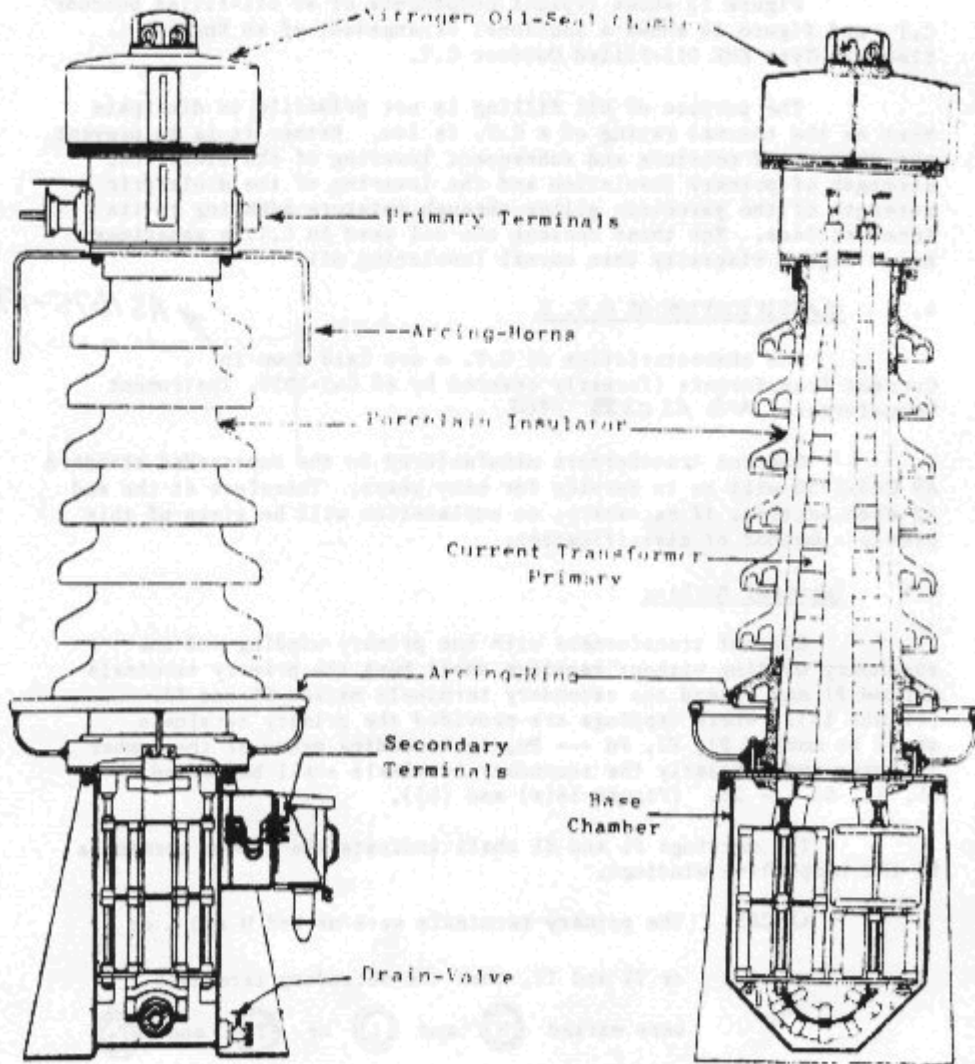

Figure 13 Typical Components of Oil-Filled Outdoor C.T. (Geyrolle)

The cores and secondary windings are housed in a sheet-steel tank which also forms the base of the C.T. The H.V. "hair-pin" passes through the ring type secondaries in the metal housing and the legs of the "hair-pin" are encased in a porcelain pillar fixed to the base tank. The pillar is suitably shedded for outdoor use.

On top of the porcelain pillar is fitted a metal cap. One H.V. connection is brought out through the cap on an insulator, the other is usually not insulated from the cap.

Figure 13 shows typical components of an oil-filled outdoor C.T. and figure 14 shows a sectional arrangement of an English Electric Type FMK Oil-Filled Outdoor C.T.

The purpose of oil filling is not primarily to dissipate heat as the thermal rating of a C.T. is low. Rather it is to prevent the ingress of moisture and subsequent lowering of the dielectric strength of primary insulation and the lowering of the dielectric strength of the porcelain pillar through moisture adhering to its inner surface. For these reasons the oil used in C.T. s sometimes has a higher viscosity than normal insulating oil.

4. CLASSIFICATION OF C.T. S





The characteristics of C.T. s are laid down in Current Transformers (formerly covered by AS C45-1950, Instrument Transformers). *AS C388-1968*

Current transformers manufactured to the superseded standard AS C45-1950 will be in service for many years. Therefore at the end of each section, if necessary, an explanation will be given of this previous method of classification.

4.1 Terminal Marking

Current transformers with one primary winding and one secondary winding without tappings shall have the primary terminals marked P1 and P2 and the secondary terminals marked S1 and S2. (Figure 15). Where tappings are provided the primary terminals shall be marked P1, P2, P3 --- Pn, in ascending order of the number of turns and similarly the secondary terminals shall be marked S1, S2, S3 --- Sn. (Figure 16(a) and (b)).

The markings P1 and S1 shall indicate the common terminals in the respective windings.

AS C45 The primary terminals were marked M and L or
or T1 and T2, then the secondary terminals
were marked  and  or  and 
respectively. See Figure 17(a) and (b).

AS 1675-1986

4.2 Protection Current Transformers

Protection C.T. s need not in general have a high degree of accuracy at normal working currents, but they must preserve their accuracy up to usually about 20 times rated current depending upon the Rated Accuracy Limit Factor. In addition, for certain types of protection, the C.T.'s must be used in matched sets in which all the transformers of a set have closely similar characteristics.

C.T. s for general protection purposes are classified in the form 10 P 150.F15, where "10" refers to the percentage composite error which under steady state conditions is the r.m.s. value of the secondary exciting current divided by the rated secondary current and the rated accuracy limit factor, expressed as a percentage.

$$\text{Composite Error \%} = \frac{I_e \times 100}{I_s \times K}$$

where I_e = r.m.s. value of the secondary exciting current,

I_s = rated secondary current

K = rated accuracy limit factor

The letter "P" indicates that it is for protection purposes.

The number "150" is the Rated Secondary Reference Voltage, i.e. the r.m.s. value of the secondary voltage in volts upon which the performance of the C.T. is based.

"F15" is the Rated Accuracy Limit Factor, which the manufacturer declares will, when applied to rated primary current, give the maximum primary current at which the C.T. will comply with the relevant accuracy clauses.

AS C45 - 10 P 150

"10" maximum declared ratio error as a percentage of 20 times rated secondary current with rated burden connected. "P" protection purposes. "150" the secondary terminal voltage at 20 times rated secondary current with rated burden connected.

4.3 Special Purpose Protection Current Transformers

Where a C.T. cannot be adequately described by the classification 4.2, the letters PL or PS shall be used.

Class "PL" are C.T. s intended for use in situations demanding a more precise indication of performance. They shall be designated by the arrangement of numerals and letters as indicated in the example:

0.05 PL 950 R3.

where 0.05 is the secondary exciting current in amperes at knee point voltage.

"PL" indicates the class. "950" is the knee point voltage in volts. "R3" designates the secondary winding resistance of 3Ω at 75°C or at maximum service temperature whichever is the greater.

Class "PS" C.T.'s in some specific respects go beyond the specification and are not fully included in the classes P or PL and the requirements of shall apply only as agreed between purchaser and manufacturer. AS 1675-1986

4.4 C.T. Ratios

The ratio of a C.T. is expressed in terms of the primary and secondary currents, e.g. a 600/5 C.T. with 600 amperes on the primary winding, has 5 amperes in the secondary winding, (the overall current ratio of the C.T. is thus 120/1). The turns ratio of a C.T. is the reciprocal of the current ratio (i.e. turns ratio = $\frac{1}{\text{current ratio}}$).

In 33kV and lower voltage stations where the area of the station is small, the lead length from the C.T. to a relay is fairly short. However, in 132kV and 330kV stations, this length can be many hundreds of yards; and, for a 5 amp C.T., the lead resistance can become a serious burden on the C.T.

For example, the rated burden for a 600/5 10 P 150 C.T. is:

$$\frac{150 \text{ volts}}{20 \times 5 \text{ amps}} = 1.5 \text{ ohms}$$

but for a 600/1, 10 P 150 C.T. the rated burden is

$$\frac{150}{20 \times 1} = 7.5 \text{ ohms}$$

Thus the conductor size necessary to keep the resistance of the leads plus relay to 1.5 ohms would be uneconomic for a long lead.

For this reason all H.V. C.T.'s now used in substations have 1 amp secondaries.

The secondaries of C.T.'s for both metering and protection purposes are generally provided with multiple ratios (e.g. 500/250/125/1). For protection purposes this is done to meet changes in anticipated load and fault conditions over a period of time. For metering purposes the multiple ratios are used so that it is necessary only to alter the C.T. ratio and meter constants for changing load conditions.

4.5 Classification of Multi-Tapped C.T.'s

Multi-tapped C.T.'s are classified similarly to single ratio C.T.'s.

Normal classification for 1000/1 C.T. could be 2.5 PS 500.

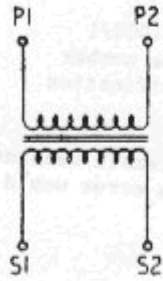
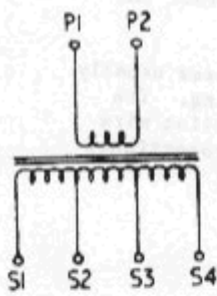
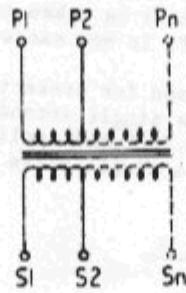

Figure 15
C.T. with One Primary and One Secondary Winding, without Tappings



(a)
C.T. with no Tappings on Primary Winding, and Tappings on Secondary Winding



(b)
C.T. with Tappings on Primary Winding, and on Secondary Winding

Figure 16

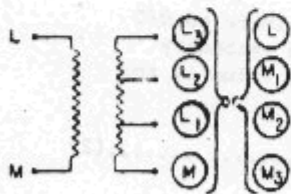

(a)
Tapped Windings

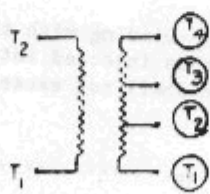

(b)
Tapped Windings

Figure 17

For multi-tapped C.T. s the classification must be referred to a particular winding.

For example:

2000/1000/500/1 C.T. is classified 5 PS 500 or 1000/1 tapping. As the secondary induced voltage varies with the number of turns we might suspect that the terminal voltage classification on other taps may be different.

As the component of magnetising current would remain reasonably constant irrespective of the tapping used, the percentage error would change with a change of tapping.

Thus the C.T. could be reclassified:

- 10 PS 250 on 500/1 tapping
- 2.5 PS 1000 on 2000/1 tapping

5. INTERPOSING AND SUMMATION C.T. S

An interposing C.T. is used in a circuit (e.g. transformer differential) when a change in ratio is required to meet the requirements of the particular condition under consideration. The primary of the interposing C.T. is connected in series with the burden of the main C.T. and care must be taken to ensure that the recommended burden of the main C.T. is not exceeded.

A summation C.T. when used for protection purposes usually has a tapped primary winding and a single secondary winding. The specific purpose of a summation C.T. (when applied to a pilot wire protection scheme) is to provide a single phase output proportional to a three phase input.

6. TESTING OF PROTECTION C.T. S

6.1 Magnetisation Test

A.S.S. C45 (1950) requires that transformers for general protection purposes shall comply with the following test. A voltage given by $V_s = 20 I_{SR} (R_B + R_S)$ (1)

where I_{SR} = rated secondary current

R_B = burden resistance (N.B. including lead resistance)

R_S = resistance of secondary winding

shall be applied to the secondary winding with the primary on O/C and the exciting current (I_{es}) thus injected into the secondary shall be measured. This current shall not exceed the value of the current given by:

$$I_{es} = \frac{r}{100} \times 20 I_{SR} \dots\dots\dots(2)$$

where r = declared maximum ratio error, as indicated by the class designation (e.g. 10 in the case of a 10 PS CT).

Example 1

The performance of a 500/1 10P 150 C.T. is to be tested.

The first step which must be taken is to measure R_S .

Suppose $R_S = 1.6\Omega$.

R_B can be determined from the last figure of the class designation.

$$R_B = \frac{150}{20 \times I_{SR}} = \frac{150}{20 \times 1} = 7.5\Omega$$

The voltage to be used for the O/C test is then given by:

$$\begin{aligned}
 V_S &= 20 I_{SR} (R_B + R_S) \dots\dots\dots (1) \\
 &= 20 \times 1 (7.5 + 1.6) \\
 &= 20 \times 9.1 \\
 &= 182 \text{ volts}
 \end{aligned}$$

When this voltage is applied to the secondary the maximum acceptable value of I_{es} is:

$$\begin{aligned}
 I_{es} &= \frac{V}{100} \times 20 I_{SR} \dots\dots\dots (2) \\
 &= \frac{182}{100} \times 20 \times 1 \\
 &= 2 \text{ amps}
 \end{aligned}$$

It will be found that formula (1) above is of more use if re-arranged:

$$\begin{aligned}
 V_S &= 20 I_{SR} (R_B + R_S) \dots\dots\dots (1) \\
 &= 20 I_{SR} R_B + 20 I_{SR} R_S
 \end{aligned}$$

Now $20 I_{SR} R_B$ is the voltage drop across the entire secondary circuit external to the C.T. when the secondary delivers 20 times I_{SR} .

Hence $20 I_{SR} R_B =$ C.T. terminal voltage corresponding to $I_S = 20 \times I_{SR}$.

$$\therefore 20 I_{SR} R_B = \text{class voltage of C.T.}$$

Let the class voltage be V_C

$$\therefore V_S = V_C + 20 I_{SR} R_S \dots\dots\dots (3)$$

Example 2

Reworking the first part of Example 1 using formula (3) gives:

$$\begin{aligned}
 V_S &= V_C + 20 I_{SR} R_S \\
 &= 150 + 20 \times 1 \times 1.6 \\
 &= 150 + 32 \\
 &= 182 \text{ volts}
 \end{aligned}$$

S 3/18/2003/17

PR 87

(24)

(* Identical with induced voltage)

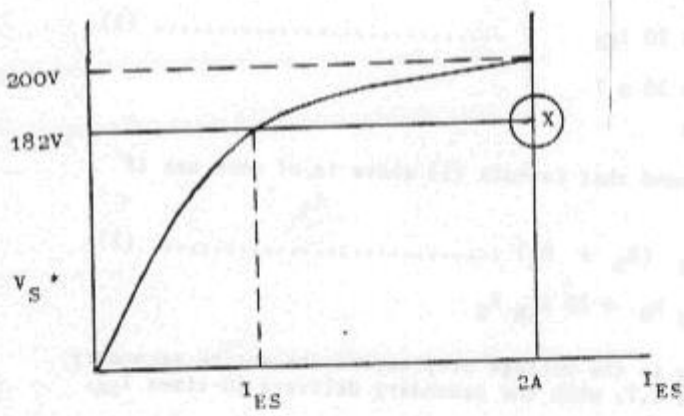

Figure 18

Although as discussed earlier a single open circuit test figure is sufficient as far as A.S. C45 is concerned to check that the performance of a C.T. complies with the standard. The usual practice is to record I_{ES} versus V_S for a range of values sufficient to take the core into saturation and enable a saturation curve to be prepared.

It is useful to note when a saturation curve is available that if the point corresponding to:

$$V_S = V_C + 20 I_{SR} R_S$$

$$\text{and } I_{ES} = \frac{I}{100} \times 20 I_{SR}$$

is plotted on the graph it will lie below the curve if the C.T. is within class and above the curve if the C.T. is not within class.

The saturation curve of an acceptable C.T. is shown in figure 18.

If a C.T. on being tested is found to be better than class, this implies that it is possible for the C.T. to carry more than the burden given on its nameplate without exceeding the declared ratio error. Alternatively, if rated burden is connected the ratio error will be less than the declared value. It is a useful exercise to determine for the first case, what burden could be connected and for the second case, what the actual ratio error would be.

Example 3

Consider the C.T. referred to in examples 1 and 2 and suppose the saturation curve obtained for this C.T. to be as in figure 18.

Figure 18 shows that when I_{ES} has the maximum value permissible for a nominal 10 P 150 C.T., $V_S = 200$ volts.

Re-arranging formula (3) gives:

$$V_C = V_S - 20 I_{SR} R_S \dots\dots\dots(4)$$

$$= 200 - 20 \times 1 \times 1.6$$

$$= 200 - 32$$

$$= 168 \text{ volts}$$

The permissible burden is given by:

$$R_B = \frac{V_C}{20 I_{SR}}$$

$$= \frac{168}{20 \times 1}$$

$$= 8.4\Omega$$

Compared with the rated burden of 7.5Ω.

S 3/78/2003/1*

13

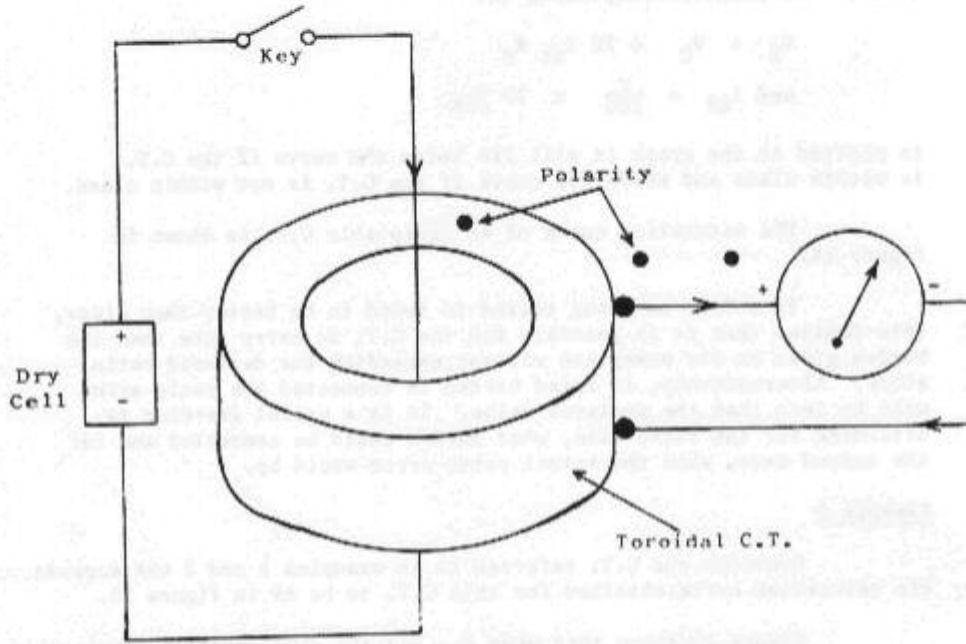

on make needle reads up scale
 on break needle kicks back stop
 current into primary polarity
 current out of secondary polarity

Figure 19 Test Circuit

The C.T. could therefore be loaded to 8.4A without exceeding the ratio error of 10%.

This can be expressed in another way - the C.T. could be "Reclassified" as 10PS168.

Example 4

Again considering the same C.T., figure 18 shows that when V_S reaches the 182 volts relevant to its nominal class of 10P150, $I_{es} = 1A$.

Re-arranging formula (2) gives:

$$R = \frac{100 I_{es}}{20 I_{SR}} \dots\dots\dots(5)$$

$$r = \frac{100 \times 1}{20 \times 1}$$

$$= 5\%$$

The C.T. could therefore drive the burden given on its nameplate without exceeding 5% ratio error.

This can be expressed in another way - the C.T. can be reclassified as 5P150.

Example 5

Three 10PS250 500/1 C.T. s are to have saturation checks carried out on them.

Step 1 - Measure secondary D.C. resistance.

Step 2 - Calculate test excitation current required - in this case:

$$I_{test} = \frac{10}{100} \times 20 I_{SR}$$

$$= 2 \text{ amps}$$

Step 3 - Set up test circuit as shown in figure and inject a range of values of current up to 2 amps and measure the required voltage in each case. This enables us to draw a magnetisation curve if required.

Step 4 - To check classification first calculate from the test figures an actual terminal voltage at $20 \times I_{SR}$ and compare this value with the class voltage given.

NOTE: It is possible that earth connections may be made on both sides of a C.T. post. This means that we have a short circuited primary winding so for this test earth must be removed.

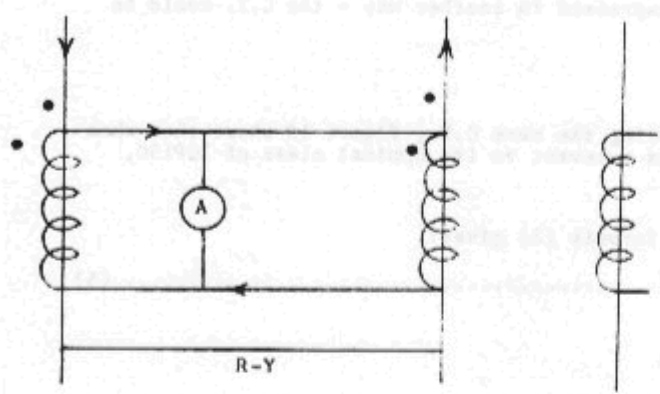

Figure 20

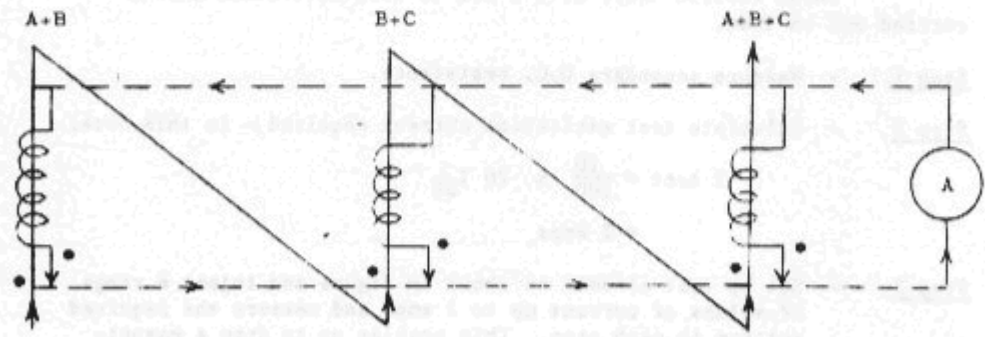

Figure 21

6.2 A.C. Ratio Check

Inject current through the primary circuit at a value as near to maximum as possible with consideration to C.T. ratio and maximum test supply rating.

- e.g. a 300/5 C.T. is 60/1 ratio
Inject 60A into primary - secondary should approximate 1.0A
- a 300/1 C.T.
Inject 60A into primary - secondary will approximate .2A
- a 400/5 C.T. is 80/1 ratio
Inject 80 amps into primary - secondary will approximate 1.0A

With protection C.T. s the output will never be a true ratio.
With metering C.T. s the ratio will be a true ratio.

6.3 D.C. Polarity Check (refer to figure 19)

Equipment - Polarised D.C. meter, battery torch cell.
Only used where C.T. are compound pitched into switchgear.

6.4 A.C. Ratio and Polarity Check on a Three Phase Set of C.T. s

Using red and yellow phases connect primary polarities or non-polarities together.

Connect the secondary polarities and secondary non-polarities together.

Place an ammeter in circuit as shown in figure 20.

Inject into open ends of primary a current equal to in value used in ratio check. If polarities are correct and ratio identical a trace will appear in the ammeter.

This test is repeated using Y and B and the B and R phases together.

NOTE: Normal terminolog for R-Y-B is A-B-C.

Thus the following tests are completed:

A-B, B-C, C-A

The tests in figure 21 should be done by injection into C.T. posts and readings taken on panel C.T. link block with normal relay burden connected.

These A.C. polarity checks are supplementary to the D.C. polarity checks and must be carried out on any commissioning job.

